

REV	DESCRIPTION	DATE
A	ISSUE	OCT/03/2012

RoHS

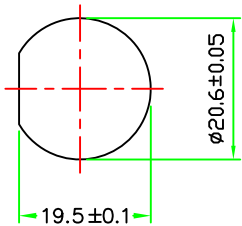

RECOMMENDED
PANEL CUT-OFF

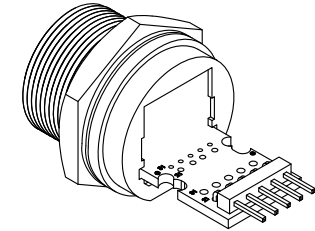
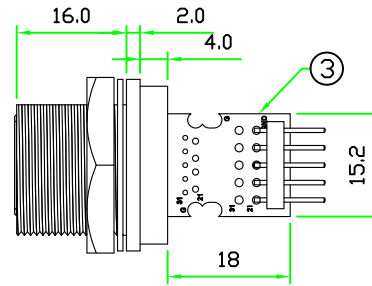
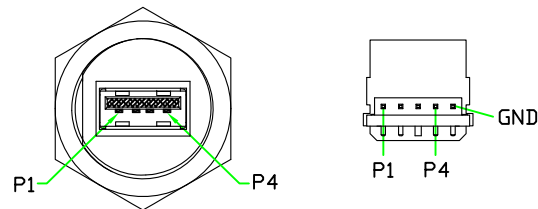
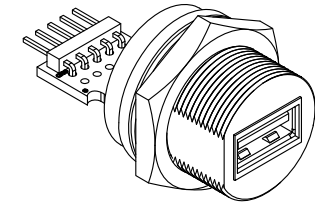
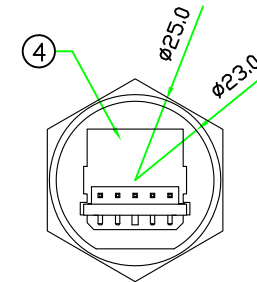
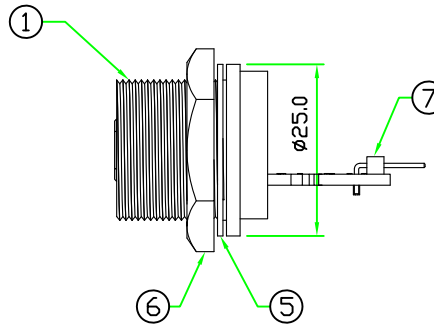
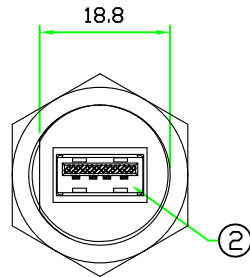

PIN ASSIGNMENT FRONT VIEW

7	PIN HEADER	PITCH 2.54mm 5P*1RAW RIGHT ANGLE PIN HEADER .	BLACK	1	
6	HEX NUT	NYLON+GF.	BLACK	1	C-NUT (42-135)
5	GASKET	EPDM.	BLACK	1	CCA-G-EP70
4	GLUE	EPOXY.	BLACK	1	
3	PCB	FR4 . DOUBLE SIDE, 1.6mm THICKNESS.		1	USBAC-PCB
2	CONNECTOR	USB 2.0 A TYPE FEMALE CONNECTOR.	WHITE	1	UA91-0401-B100-R
1	BODY	USB A TYPE FEMALE CONNECTOR BODY. NYLON+GF.	BLACK	1	USBAC-P3C (89-135-N3-3)
No.	PART NAME	DESCRIPTION	COLOR	Q'TY	REMARKS

HOLIN® Allconnectors

www.allconnectors.eu | info@allconnectors.eu
Tel: +49 (0)711 / 358 110 20 | Fax: +49 (0)711 / 358 110 25

UNIT: mm
SCALE 1:1

TITLE : USB 2.0 A TYPE FEMALE C SIZE SCREW TYPE CIRCULAR FLANGE PANEL WITH RIGHT ANGLE PIN HEADER

P/N: USB2AC-P3C12

DWG.NO: USB2AC-P3C12

UNLESS OTHERWISE SPECIFIED TOLERANCES:
X ±0.25 XX ±0.1
XXX ±0.05 ANGLE ± 1°X

REV. A SHEET 1/1

DR. jaek
CH. Michael
AP.