

RoHS

REV	DESCRIPTION	DATE
A	ISSUE	Jan/10/2013

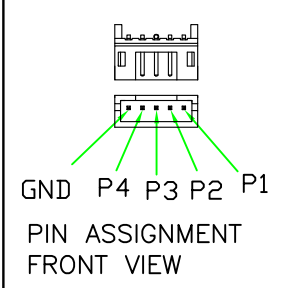
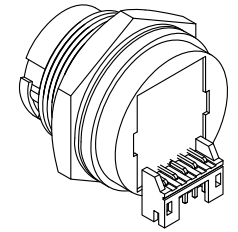
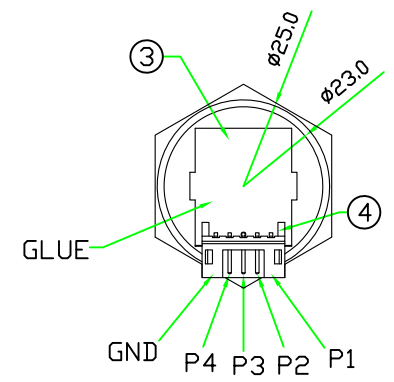
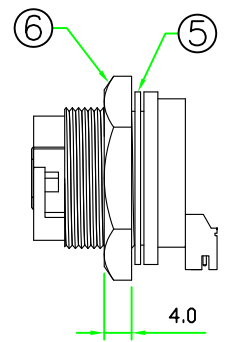
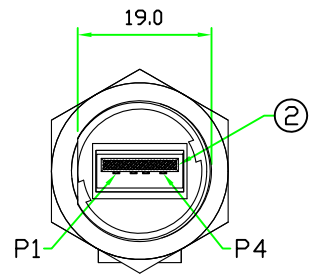
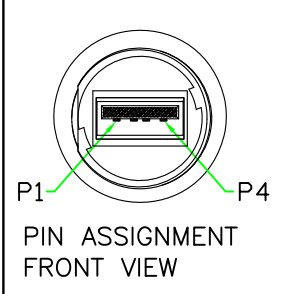
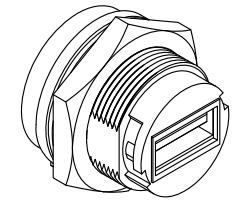
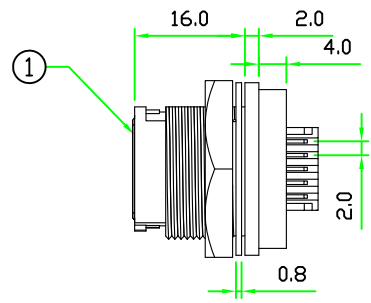
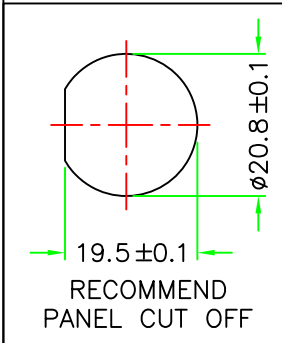

6	HEX NUT	NYLON+GF.	BLACK	1	RJ45USB-NUT
5	GASKET	EPDM.	BLACK	1	CCA-G
4	WAFER	PITCH 2.0mm, RIGHT ANGLE. 5P*1ROW.	BLACK	1	
3	PCB	FR4 . DOUBLE SIDE, 1.0mm THICKNESS.		1	USBABF-PCB
2	CONNECTOR	USB A TYPE FEMALE CONNECTOR.		1	
1	BODY	USB A TYPE FEMALE CONNECTOR BODY. NYLON+GF.	BLACK	1	USBAC-LC
No.	PART NAME	DESCRIPTION	COLOR	Q'TY	REMARKS

HOLIN®

www.allconnectors.eu | info@allconnectors.eu
Tel. +49 (0)711 / 358 110 20 | Fax +49 (0)711 / 358 110 25

UNIT: mm
SCALE: 1:1

TITLE : USB A TYPE FEMALE C SIZE
LOCK TYPE CIRCULAR FLANGE PANEL
5 PIN RIGHT ANGLE WAFER

P/N: USB2AC-L3C04
DR. *jaek*
CH. *Michael*

DWG.NO: USB2AC-L3C04
AP.

UNLESS OTHERWISE SPECIFIED TOLERANCES:
x ±0.25 xx ±0.1
xxx ±0.05 ANGLE ± 1°
REV. SHEET 1/1