

REV.	Description	Date

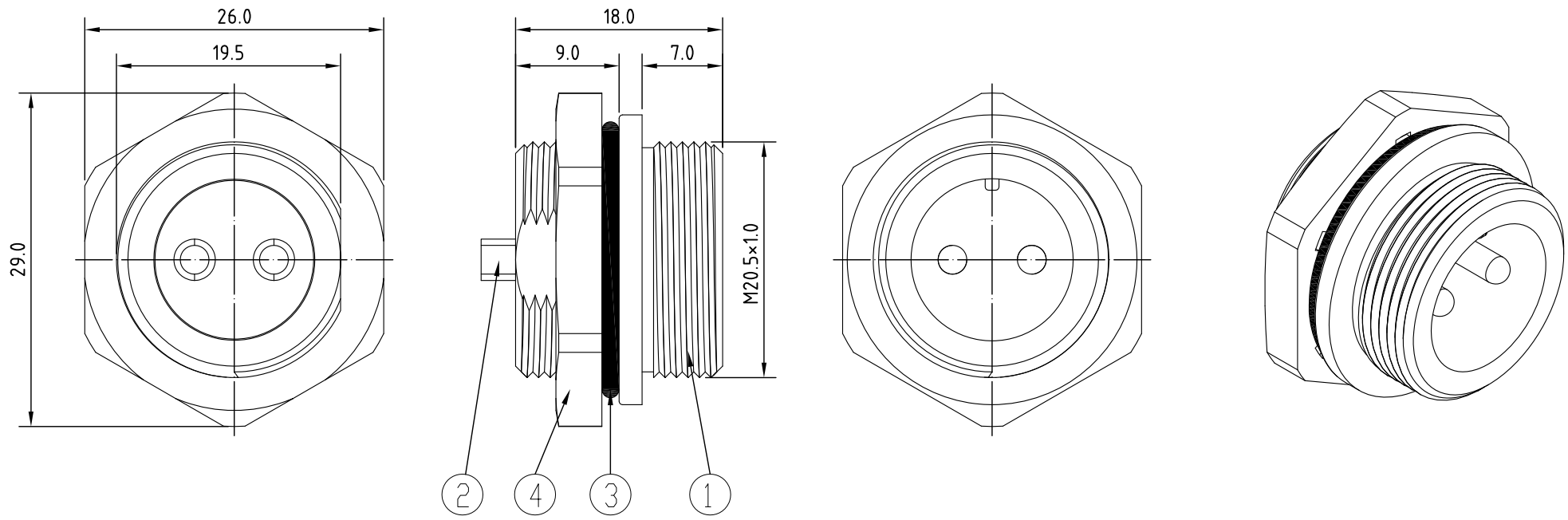

RoHS
 LEAD FREE
 TOLERANCE .X±0.25 .XX±0.10

CONTACT ARRANGEMENT FRONT VIEW (MALE)	2P	3P	4P	5P	6P	7P	8P	2+8P

4	Nut	PA	
3	O ring	Rubber	
2	Pin	Brass	Nickel plated
1	Body	PA	
Item	Description	Material	Treat & Remark

All Connectors
 www.allconnectors.eu | info@allconnectors.eu
 Tel. +49 (0)711 / 358 110 20 | Fax +49 (0)711 / 358 110 25

DATE	3/26/2012	PART NO.	SD264F2-XP
DWN	GINA	REV.	0
CHK			
UNIT	MM		

ITEM	Sensor Connector M20.5
------	------------------------