

REV.	Description	Date

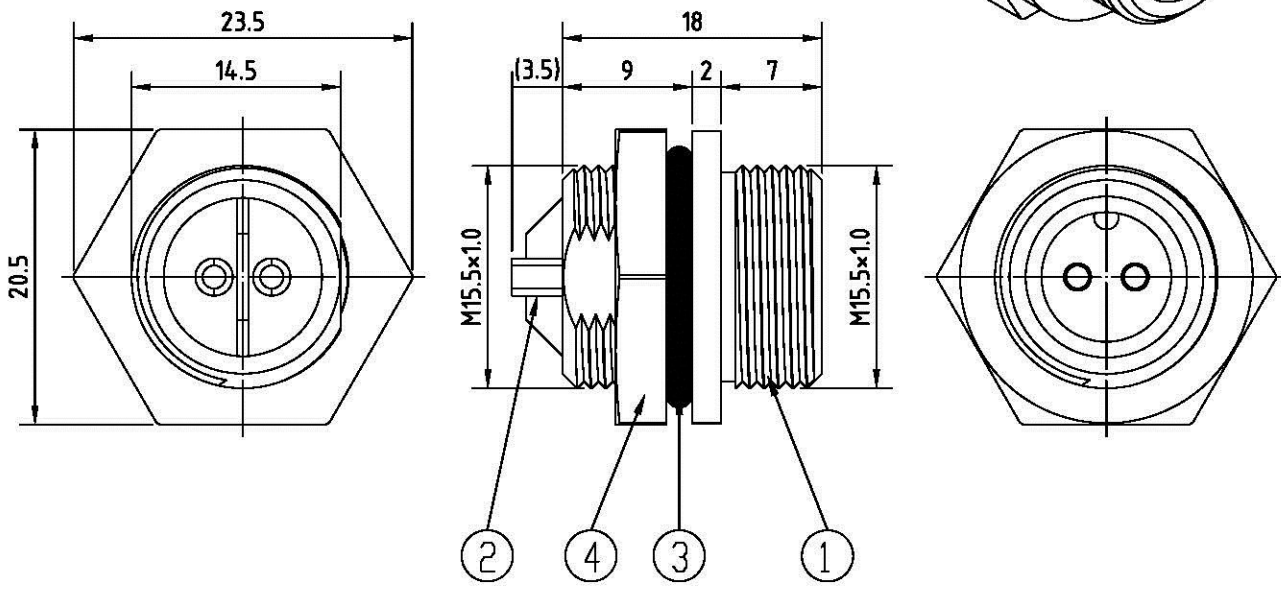

Specification of connector

- Locking system : screw M15.5
- Termination : solder
- Shell protection : IP68
- Rated voltage : 250V
- Rated current : 10A
- Contact resistance : $\leq 10\text{m}\Omega$
- Insulation resistance : $>10\text{M}\Omega$

RoHS
LEAD FREE
TOLERANCE $X\pm 0.5$ $X.X\pm 0.3$

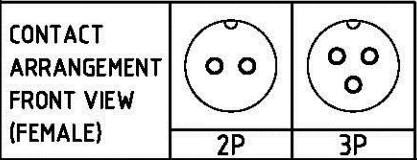

4	Nut	PA	
3	O ring	Rubber	
2	Pin	Brass	Gold plated
1	Body	PA	
Item	Description	Material	Treat & Remark

Allconnectors

www.allconnectors.de
Tel.: 0049 711 7009503
70794 Filderstadt - Germany

info@allconnectors.de
Fax: 0049 711 7009504
Kettenerstr. 25

DATE	6/15/2012	PART NO.	UT-SD210M2-XP
DWN	GINA	REV.	0
CHK			
UNIT	MM		

ITEM	Sensor Connector M15.5
------	------------------------