

Recommended
Panel cut-out

REV.	Description	Date

Specification of connector

Locking system : Quick Push Lock
 Termination : solder
 Shell protection : IP68
 Contact resistance : <10mΩ
 Insulation resistance : >10MΩ

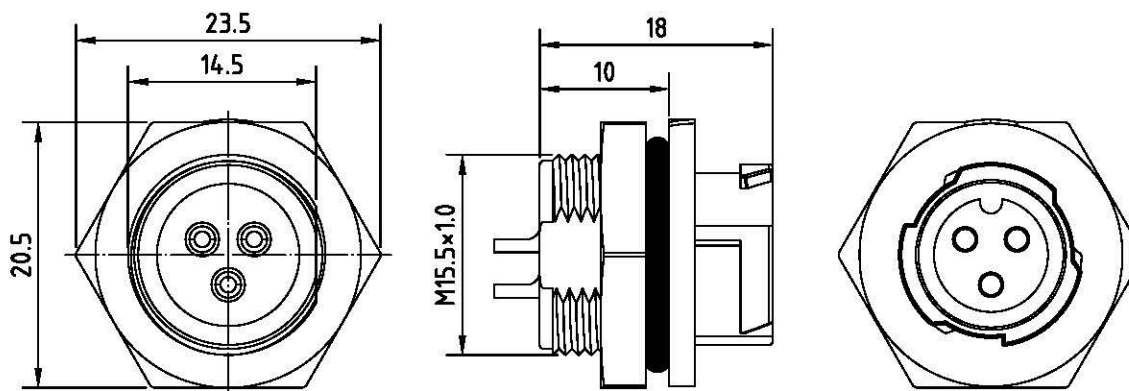

RoHS
 TOLERANCE X±0.5 X.X±0.3

CONTACT ARRANGEMENT FRONT VIEW (FEMALE)	2P	3P	4P	5P	6P	7P	8P
Rated voltage	250V		250V		60V		
Rated current	10A		5A		5A		

4	Nut	PA	
3	O ring	Rubber	
2	Pin	Brass	Gold plated
1	Body	PA	
Item	Description	Material	Treat & Remark

Allconnectors

www.allconnectors.de
 Tel.: 0049 711 7009503
 70794 Filderstadt - Germany

info@allconnectors.de
 Fax: 0049 711 7009504
 Kettnerstr. 25

DATE	2019/12/17	PART NO.	SD363M2-XP
DWN	GINA	REV.	0
CHK			
UNIT	MM		

ITEM	Type J(J1): female conn. 2-8P
------	-------------------------------