

REV.	Description	Date
1	dimensions revised	2020/2/5

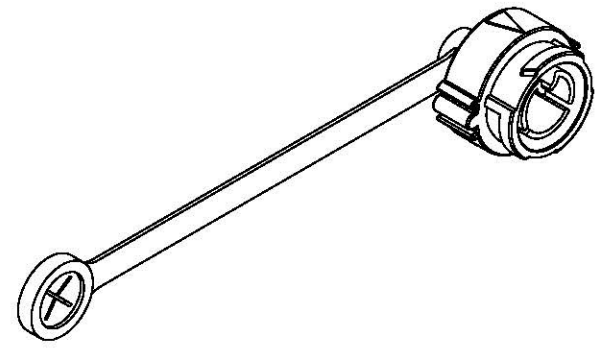
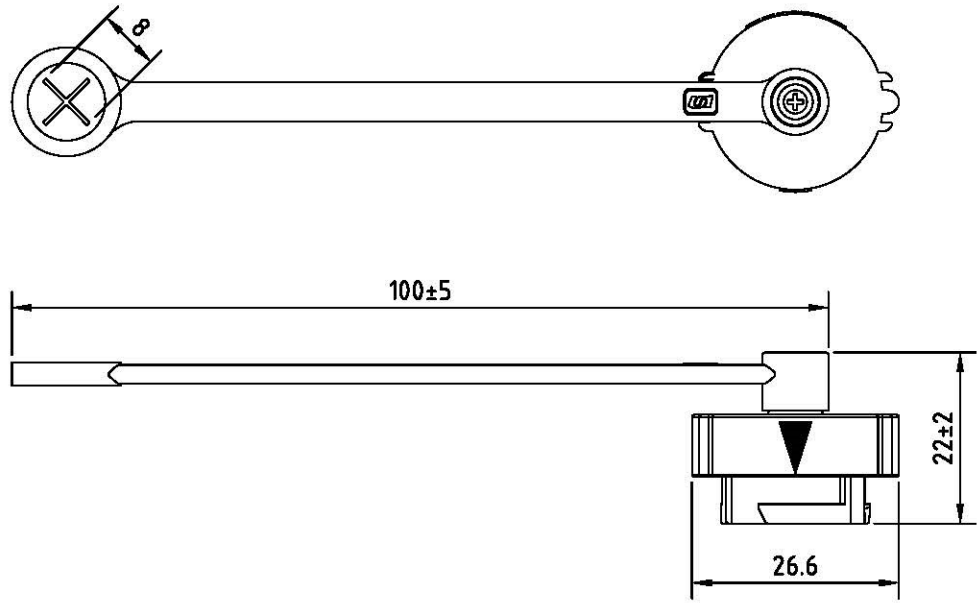

RoHS  
TOLERANCE ±0.5

4	Screw	SUS	
3	Washer	SUS	
2	Cable tie	PVC	
1	Cap	PA	
Item	Description	Material	Treat & Remark

**Allconnectors**

www.allconnectors.de  
Tel.: 0049 711 7009503  
70794 Filderstadt - Germany

info@allconnectors.de  
Fax: 0049 711 7009504  
Kettenerstr. 25

DATE	2020/2/5	PART NO.	D365C-6B
DWN	GINA	REV.	1
CHK			
ITEM	Type J(J3): waterproof cap	UNIT	MM