

REV.	Description	Date
1	dimensions revised	2020/2/5

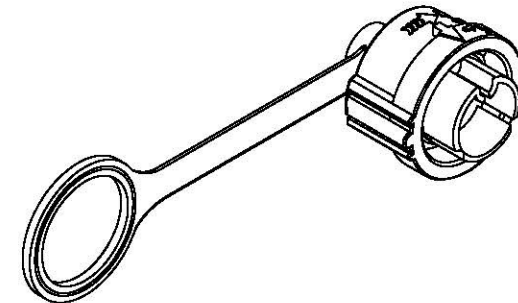
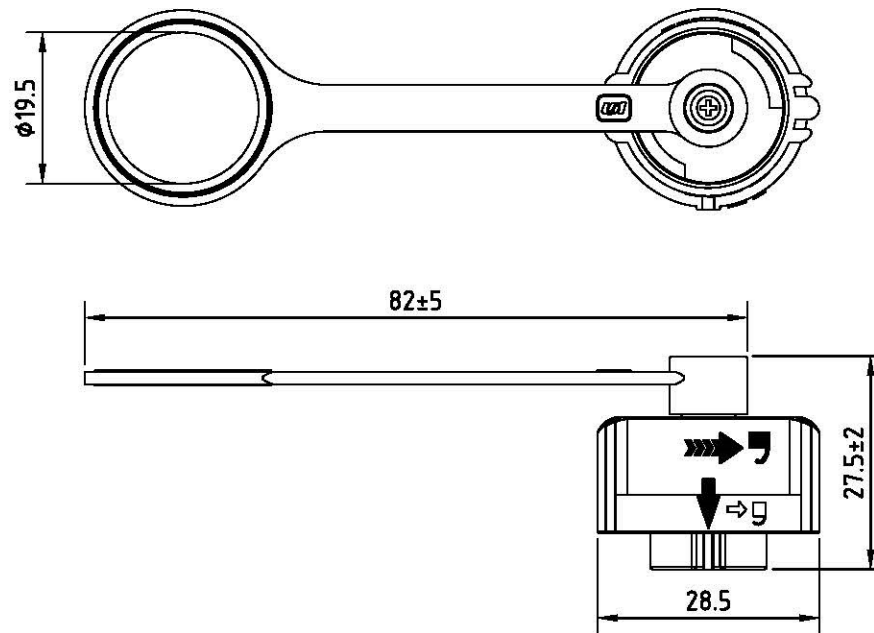

RoHS
TOLERANCE ±0.5

5	Screw	SUS	
4	Washer	SUS	
3	Cable tie	PVC	
2	O ring	Rubber	
1	Cap	PA	
Item	Description	Material	Treat & Remark

Allconnectors

www.allconnectors.de
Tel.: 0049 711 7009503
70794 Filderstadt - Germany

info@allconnectors.de
Fax: 0049 711 7009504
Kettenerstr. 25

DATE	2020/2/5	PART NO.	D365C-12C
DWN	GINA	REV.	1
CHK			
ITEM	Type J(J4): waterproof cap	UNIT	MM