

REV.	ECN NO.	DATE	SIGN	DESCRIPTION
A		2008/11/19	Simon Hung	Change the Rev.01 to Rev.A
B	LEN-931015	2009/03/25	Simon Hung	Change 28.5 TO 28.8

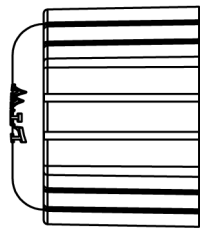

③ Seals Nut

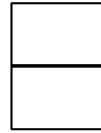

④ Seals

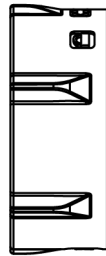

② Bayonet Nut

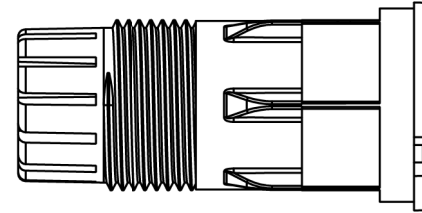

① Clamp Ring



⑤ Gasket

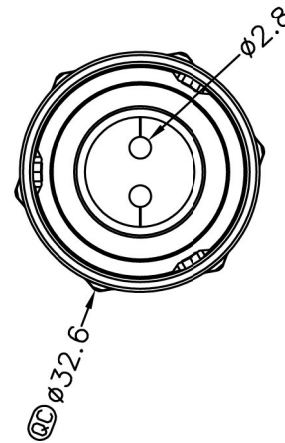
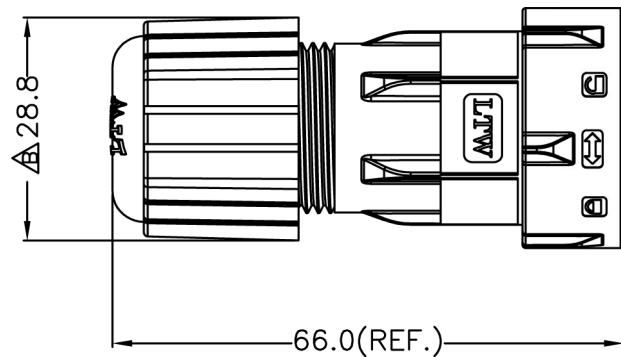
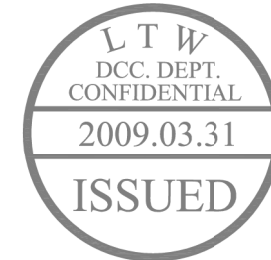
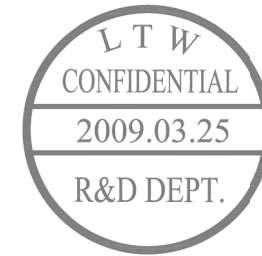

Note:

- * ϕ Important Dimension.
- * Waterproof Rating: IP67
- * Cable OD: $\phi 2.5 \sim \phi 2.8$ mm Max.
- * Clamp Ring: PPO,UL94V-0,Black.
- * Bayonet Nut: PPO,UL94V-0,Black.
- * Sealing Nut: Nylon+GF,UL94V-0,Black.
- * Seals: Silicone,UL94V-0,Gray.
- * Gasket: Silicone,UL94V-0,Gray.

①②③④⑤ 組裝放入一個 PE 袋
 ③ 只需鎖 3~4 牙
 (Assembly Put In One PE Bag)

UNIT:mm		TITLE FIBER OPTICAL CABLE ASS'Y TYPE	
TOLERANCE		SCALE Free	SHEET 1 OF 1
.X	±0.25	REV. B	SIZE A4
.XX	±0.1	④ : Inspection Item	
.XXX	±0.05		
ANGLES	±1'		

LTW
All connectors
www.allconnectors.eu | info@allconnectors.eu
 Tel. +49 (0)711 / 358 110 20 | Fax +49 (0)711 / 358 110 25

ITEM NO LTWFB-00BLMA-LL7001	DRAWN BY Simon	DATE 2009/03/25
DWG NO LTWFB-00BLMA-LL7001	CHECKED BY Kathy	DATE 2009/03/25
CUSTOMER	APPROVED BY Yitung	DATE 2009/03/25

THIS DOCUMENT IS SUBJECT TO CHANGE WITHOUT NOTICE. IT IS CONFIDENTIAL AND A PROPERTY OF LTW. DISCLOSURE TO THIRD PARTY HAS TO BE AUTHORIZED BY LTW.