

REV.	DESCRIPTION	DATE
A	ISSUE	Dec/05/2013

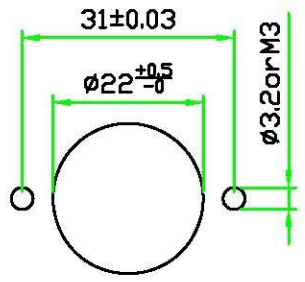

RECOMMENDED
PANEL CUT OUT

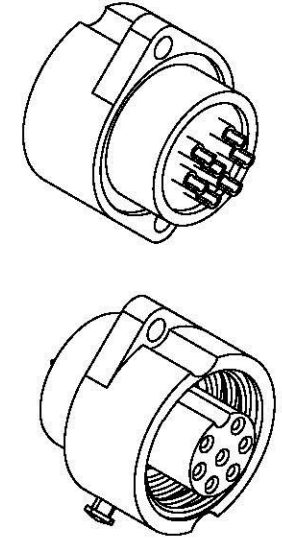
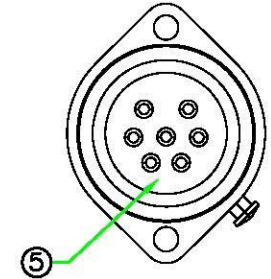
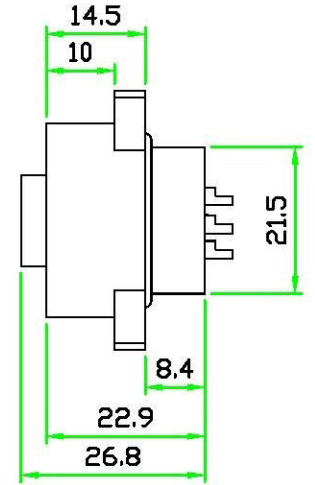
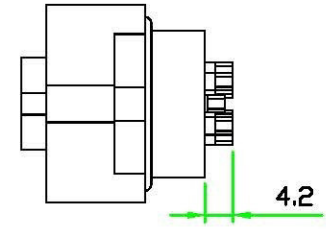
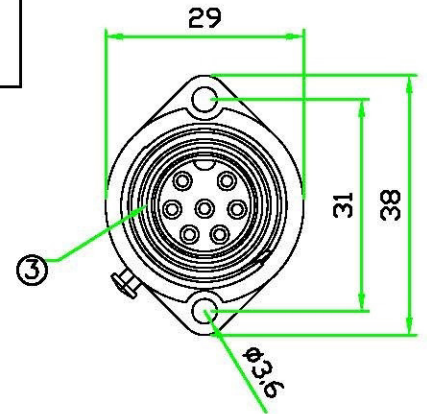

RoHS

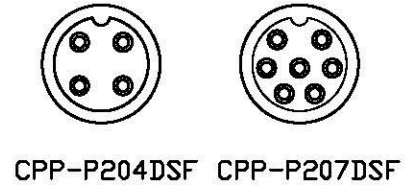
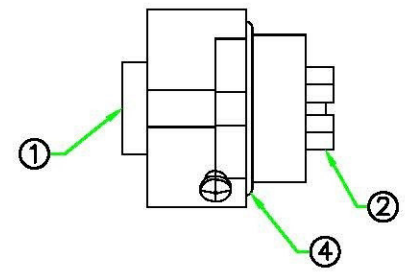
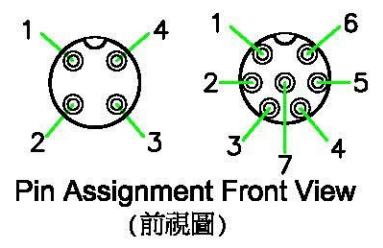

5	GLUE	EPOXY .	BLACK	1	
4	O-RING	NBR.	BLACK	1	O-1620-EK
3	O-RING	NBR .	BLACK	1	C16-F-P-N
2	CONTACT	BRASS, FEMALE PIN, 6u" GOLD PLATED.		N	F1.5SPL24.5
1	CONNECTOR	NYLON+GF.	BLACK	1	CPP-PP2xxC
No.	PART NAME	DESCRIPTION	COLOR	Q'TY	REMARKS

All Connectors

www.allconnectors.de info@allconnectors.de
Tel.: 0049 734 700503 Fax: 0049 734 700504
70794 Filderstadt - Germany Kettelerstr. 25

	UNIT: mm	TITLE CIRCULAR P SIZE FEMALE SOLDER PIN SCREW TYPE ROUND FLANGE SCREW MOUNT PANEL CONNECTOR
SCALE	1:1	
UNLESS OTHERWISE SPECIFIED TOLERANCES: x ±0.25 xx ±0.1 xxx ±0.05 ANGLE ± 1°		P/N: CPP-P2xxDSF
REV. A	SHEET 1/1	DR. JACK CH. MICHAEL AP.
DWG.NO: CPP-P2xxDSF		