

RECOMMENDED
PANEL CUT OUT

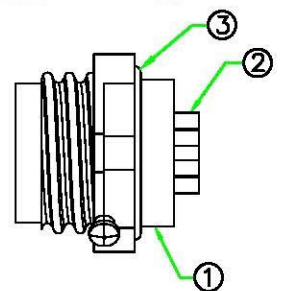

REV.	DESCRIPTION	DATE
A	ISSUE	Dec/05/2013

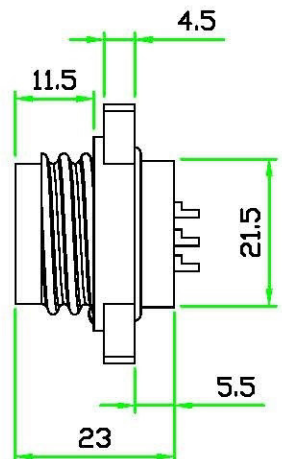
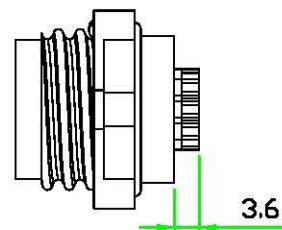
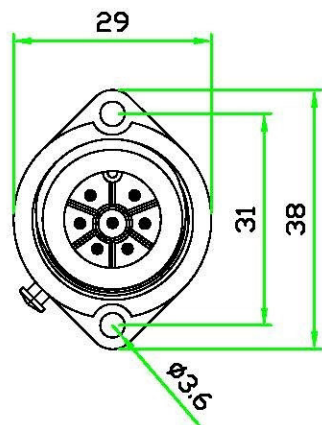
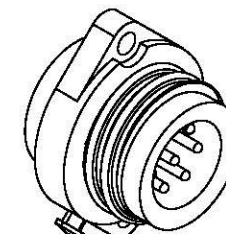
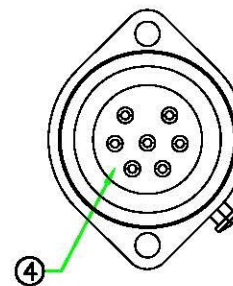
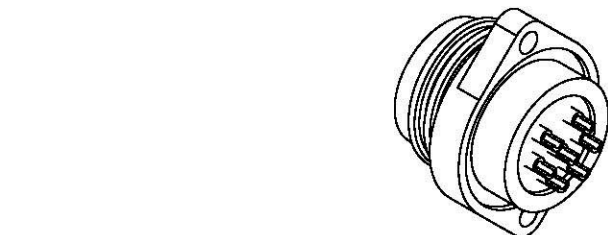

RoHS

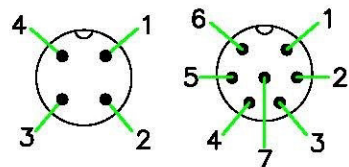

Pin Assignment Front View
(前視圖)

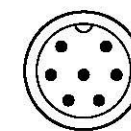
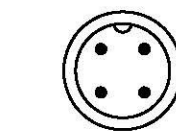

CPP-P104DSF

CPP-P107DSF

All Connectors
 www.allconnectors.de info@allconnectors.de
 Tel: 0049 711 7095503 Fax: 0049 711 7095504
 70794 Miltosried, Germany Kollmstr. 22

3	GLUE	EPOXY .	BLACK	1		UNIT: mm SCALE 1:1	TITLE CIRCULAR P SIZE MALE SOLDER PIN SCREW TYPE ROUND FLANGE SCREW MOUNT PANEL CONNECTOR	P/N: CPP-P1xxDSF	DR. JACK CH. MICHAEL AP.
3	O-RING	NBR.	BLACK	1	O-1620-EK				
2	CONTACT	BRASS, MALE PIN, 6u" GOLD PLATED.		N	M1.5SPL24.5	UNLESS OTHERWISE SPECIFIED TOLERANCES: * ±0.25 ** ± 0.1 XXX ± 0.05 ANGLE ± 1° REV: A SHEET 1/1	DWG.NO: CPP-P1xxDSF	DR. JACK CH. MICHAEL AP.	
1	CONNECTOR	NYLON+GF.	BLACK	1	CPP-PP1xxC (190-135)				
No.	PART NAME	DESCRIPTION	COLOR	Q'TY	REMARKS	A	1/1	CPP-P1xxDSF	AP.