

SPECIFICATIONS

CONTACT RATING: 6A @125 VAC or 28 VDC (Q terminal)
 ELECTRICAL LIFE: 50,000 make-and-break cycles at full load
 CONTACT RESISTANCE: 10 mΩ max. initial @2-4 VDC,100 mA
 INSULATION RESISTANCE: 1,000 MΩ min.
 DIELECTRIC STRENGTH: 1,500 V RMS @ sea level.
 OPERATING TEMPERATURE: -30°C to +85°C

MATERIALS

CASE & BUSHING- Glass filled nylon 6/6 or nylon 4/6 (UL94V-0)
 ACTUATOR - Nylon, black standard, internal o-ring
 seal standard with all actuators
 SWITCH SUPPORT- Copper alloy or steel, tin plated
 CONTACT AND TERMINAL- Copper alloy, silver plated
 TERMINAL SEAL- Epoxy

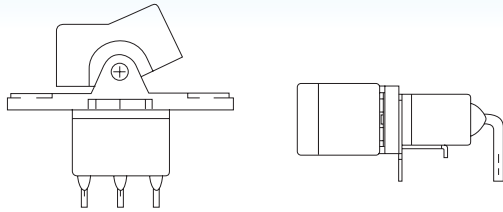

INDEX

TOGGLE

ROCKER

SLIDE

PUSH BUTTON

DIP

TACT

How do you build the switches you need!!

The straight terminal type , please see the (A) ;

The right angle P.C terminals, please see the (B)

(A) N E R 8 0 1 5 - R 1 1 - 2 - C Q - S 2 0 -

Switches Function		Actuator	Actuator Color	Termination	Contact Material	Vertical support Bracket
NER8015	SP on-none-on	R11	1 white	B solder lug	Q silver plated	(none) 11.68
NER8015A	SP on-none-(on)	R21	2 black(std)	C P.C 1.27width	R gold plated	
NER8016	SP on-off-on	P13	3 red	D Quick connect	G gold over silver	RoHS code H = RoHS Compliant
NER8016A	SP (on)-off-(on)	P23	4 orange	D1 wire wrap 19.05	K tin plated	
NER8016B	SP on-off-(on)		5 yellow	D3 wire wrap 10.8		
NER8017	DP on-none-on		6 green			
NER8017A	DP on-none-(on)		7 blue			
NER8018	DP on-off-on		9 gray			
NER8018A	DP (on)-off-(on)					
NER8018B	DP on-off-(on)					
3 way position switches			now the available is code "1/2/3". The other please inquire first			
NER818	SP3T on-on-on					

(B) N E R 8 0 1 5 P - R 1 1 - 2 - Q -

Horizon Right Angle	Vertical Right Angle	Switches Function	Actuator	Actuator Color	Contact Material	RoHS code
NER8015P	NER8015L / NER8013L	SP on-none-on	R11	1 white	Q silver plated	H = RoHS Compliant
NER8015PA	NER8015LA / NER8013LA	SP on-none-(on)	R21	2 black(std)	R gold plated	
NER8016P	NER8016L / NER8014L	SP on-off-on	P13	3 red	G gold over silver	RoHS code H = RoHS Compliant
NER8016PA	NER8016LA / NER8014LA	SP (on)-off-(on)	P23	4 orange	K tin plated	
NER8016PB	NER8016LB / NER8014LB	SP on-off-(on)		5 yellow		
NER8017P	NER8017L / NER8011L	DP on-none-on	The right angle type cannot have frame.	6 green		
NER8017PA	NER8017LA / NER8011LA	DP on-none-(on)		7 blue		
NER8018P	NER8018L / NER8012L	DP on-off-on		9 gray		
NER8018PA	NER8018LA / NER8012LA	DP (on)-off-(on)				
NER8018PB	NER8018LB / NER8012LB	DP on-off-(on)				
3 way position switches				now the available is code "1/2/3". The other please inquire first		
NER818P/ NER818L/ NER812L		SP3T on-on-on				

SPDT

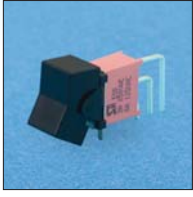

Model No.	Switching position		
NER8015L	ON	none	ON
NER8015LA	ON	none	(ON)
NER8016L	ON	OFF	ON
NER8016LA	(ON)	OFF	(ON)
NER8016LB	ON	OFF	(ON)
Term. Comm.	2-3	open	2-1

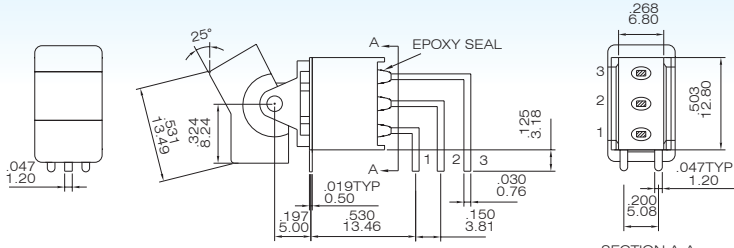

NER8015L- R11-2-Q

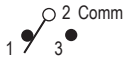

SPDT

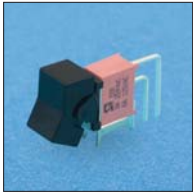

Model No.	Switching position		
NER8013L	ON	none	ON
NER8013LA	ON	none	(ON)
NER8014L	ON	OFF	ON
NER8014LA	(ON)	OFF	(ON)
NER8014LB	ON	OFF	(ON)
Term. Comm.	2-3	open	2-1

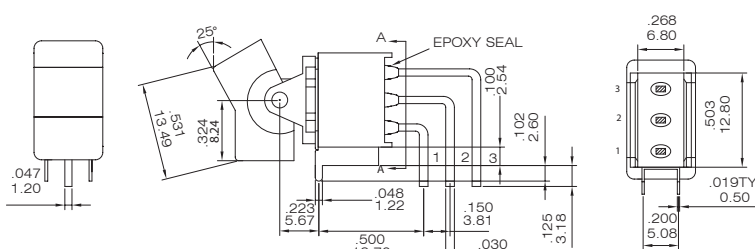

NER8013L- R11-2-Q

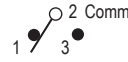

DPDT

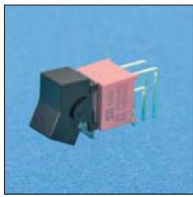

Model No.	Switching position		
NER8017L	ON	none	ON
NER8017LA	ON	none	(ON)
NER8018L	ON	OFF	ON
NER8018LA	(ON)	OFF	(ON)
NER8018LB	ON	OFF	(ON)
Term. Comm.	2-3,5-6	open	2-1,5-4
3 way switches			
NER818L	ON	ON	ON
Term. Comm.	2-3,5-6	2-3,5-4	2-1,5-4

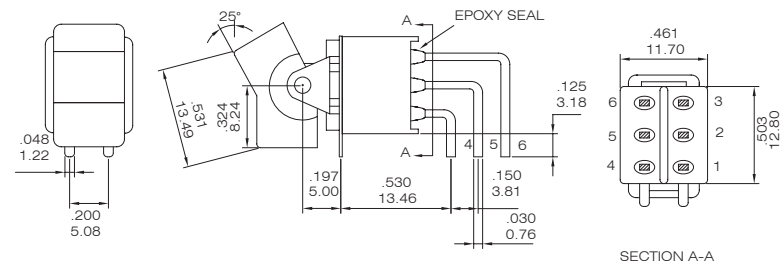

NER8017L- R11-2-Q

Please see page B12 to know more about NER818L (3-way Switches)



DPDT

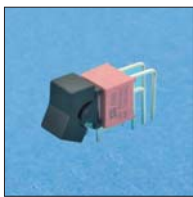

Model No.	Switching position		
NER8011L	ON	none	ON
NER8011LA	ON	none	(ON)
NER8012L	ON	OFF	ON
NER8012LA	(ON)	OFF	(ON)
NER8012LB	ON	OFF	(ON)
Term. Comm.	2-3,5-6	open	2-1,5-4
3 way switches			
NER812L	ON	ON	ON
Term. Comm.	2-3,5-6	2-3,5-4	2-1,5-4

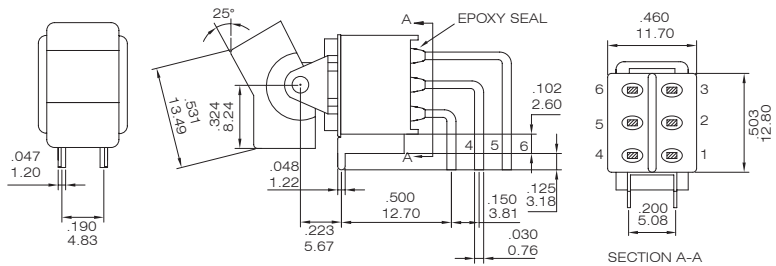

NER8011L- R11-2-Q

Please see page B12 to know more about NER812L (3-way Switches)



FOR NER8015P-NER8016PB

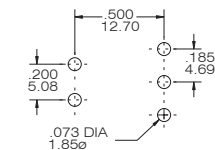

FOR NER8017P-NER8018PB

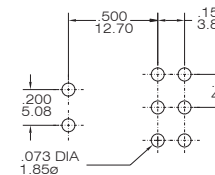

FOR NER8015L-NER8016LB

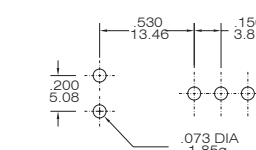

FOR NER8013L-NER8014LB

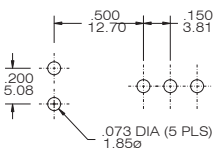

FOR NER8017L-NER8018LB

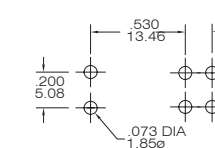

FOR NER8011L-NER8012LB

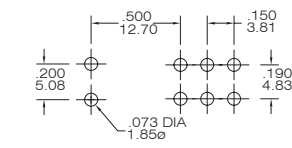

Actuator Option

R11

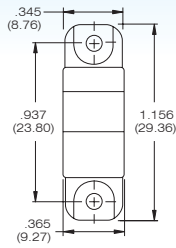

R21

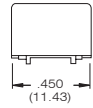
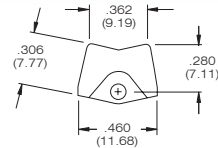
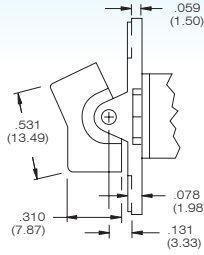

P13

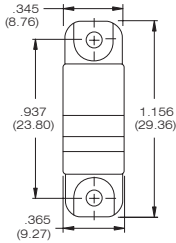

P23

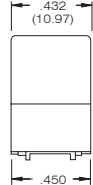
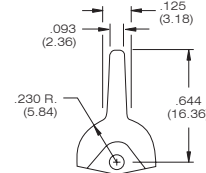
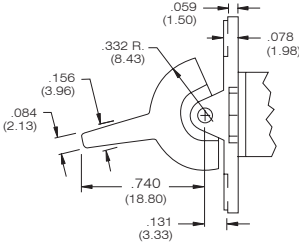

Panel Mounting

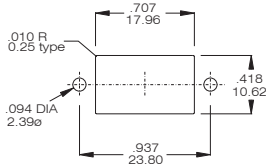

R11 / P13

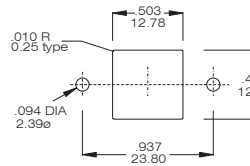

R21 / P23

Terminal Option (only for straight type NER8015~NER8018)

B SOLDER LUG

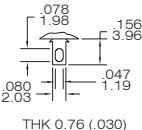

THK 0.76 (.030)

C PRINTED CIRCUIT

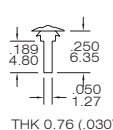

THK 0.76 (.030)

D QUICK CONNECT

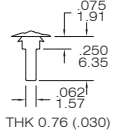

THK 0.76 (.030)

WIREWRAP

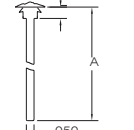

THK 0.76 (.030)

WIREWRAP

CODE	"A" dimension
D1	.750 (19.05)
D3	.425 (10.8)

CONTACT MATERIAL OPTIONS

CODE	CONTACT MATERIAL	TERMINAL MATERIAL	RATING
Q	Silver plated	Silver plated	6 A @ 125V AC or 28 V DC; 3 A @ 250 VAC
R	Gold plated over nickel plated	Gold plated over nickel plated	0.4VA MAX @ 20 V AC or DC MAX
G	Gold plated over silver plated	Gold plated over silver plated	0.4 VA MAX @ 20 V AC or DC MAX or 6 A @ 125V AC or 28 V DC; 3 A @ 250 VAC
K	Gold plated over nickel plated	Tin over nickel plated	0.4VA MAX @ 20 V AC or DC MAX

* THE K option is only for some special item. Please inquire first when you need the "K" option

VERTICAL SUPPORT BRACKET (only apply the straight type terminal: page B02)

S20 (SPDT)

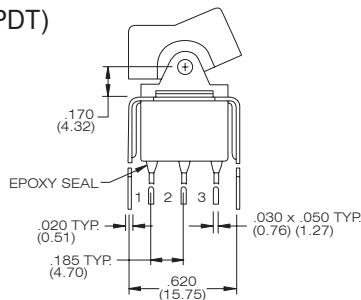
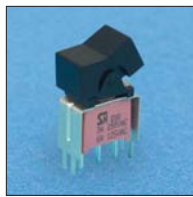

NER8015-R11-2-CQ-S20

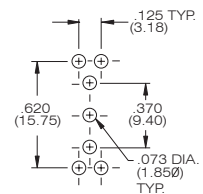
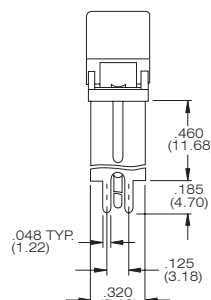

S20 (DPDT)

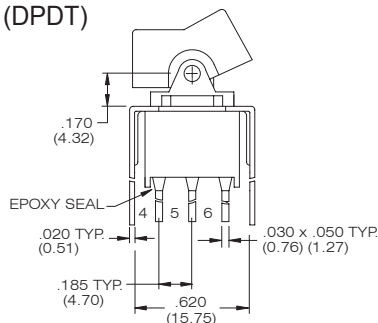
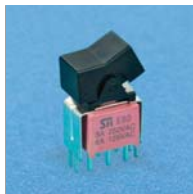

NER8017 - R11-2-CQ-S20

