

WITHOUT CARD

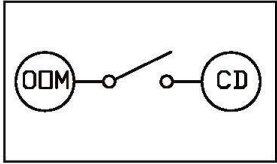

CARD INSERTED

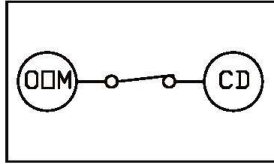

CARD DETECT SW. STATUS.

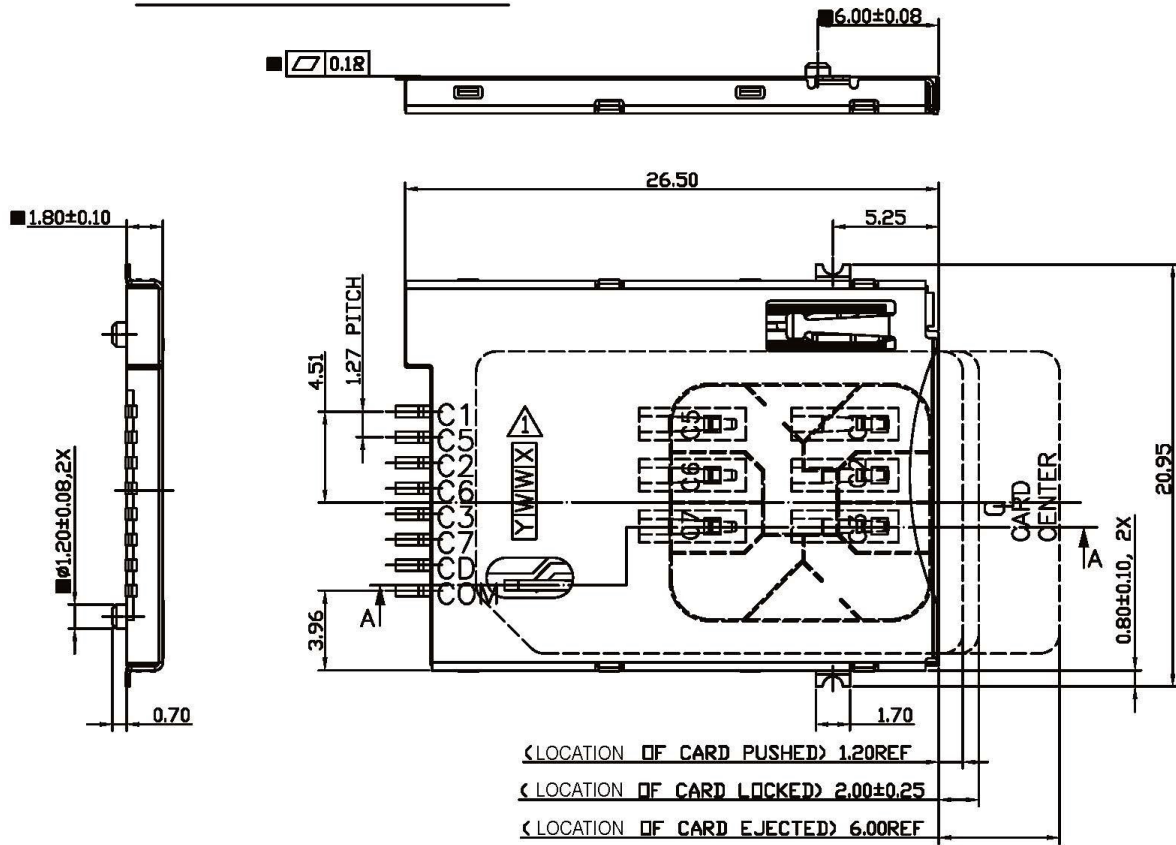

- NOTES:
- MATERIAL:
HOUSING: LCP+30% G.F., UL 94V-0 RATED, COLOR BLACK.
CONTACTS: COPPER ALLOY.
SHIELD COVER: SUS304, 0.2T.
 - PLATING:
CONTACT AREA: HARD GOLD PLATING OVER 1.27µm (50µ") MIN, NICKEL UNDERPLATING.
SOLDERING ZONE: 3.05µm (120µ") MIN. 100% TIN, OR LEAD-FREE PLATING PER PART NUMBER DESIGNATION, OVER NICKEL UNDERPLATING.
SHIELD COVER: GOLD FLASH NICKEL UNDERPLATING.
UNDERPLATING: 1.27µm (50µ") MIN. NICKEL ALLOVER.
 - CUTTING BURR ALLOWED: 0.03mm MAX.
 - THE DIMENSIONS MARKED WITH '■' ARE CRITICAL DIMENSIONS.
 - COPLANARITY IS 0.10mm MAX.
 - RoHS COMPLIANT PRODUCTS.
 - DATE CODE MARKING:

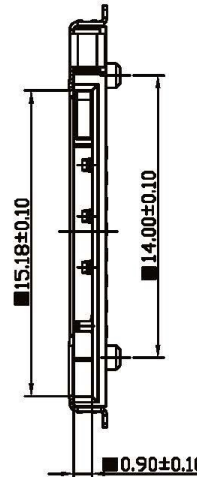
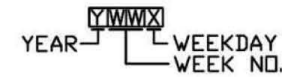

PARTS LIST

ITEM	DESCRIPTION	QTY(PC'S)
1	HOUSING	1
2	SLIDER	1
3	MAIN CONTACT	1
4	OOM CONTACT	1
5	CD CONTACT	1
6	METAL COVER	1
7	CRANK	1
8	SPRING	1

RoHS Compliant

All Connectors

www.allconnectors.de info@allconnectors.de
Tel.: 0049 711 7009503 Fax: 0049 711 7009504
70794 Filderstadt - Germany Kettenerstr. 25

DRAWING BY CY		TOLERANCES ARE X.± X.± .XX.± .XXX.± ANG.±
CHECKED BY GENIUS		
UNIT / mm	SCALE 1 : 1	
DATE		
SIZE A4	PPOJECTION	



ORDER INFORMATION

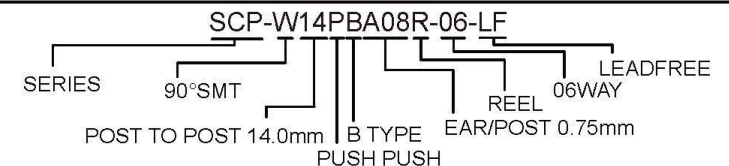

DESCRIPTION: SIM Card Socket 6+2 Pin Push-Push Type

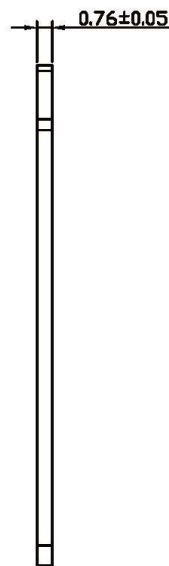
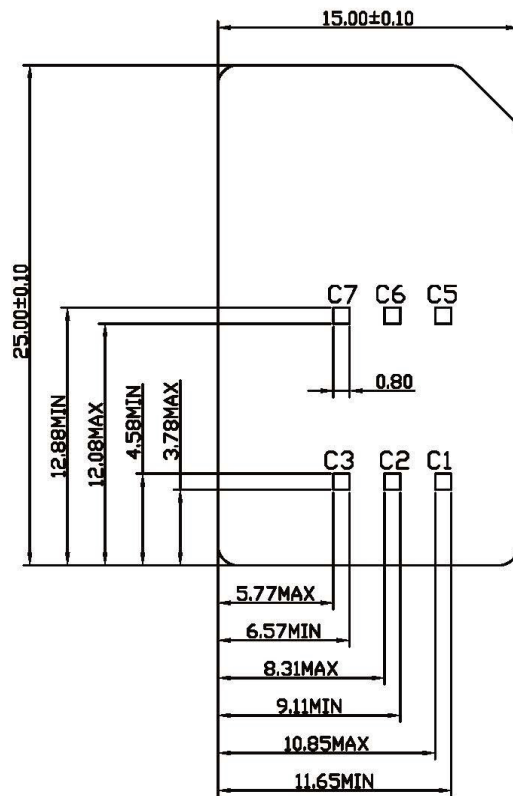

APPLICABLE CARD SIZE

- C1 Supply voltage(VCC)
- C2 Reset(RST)
- C3 Clock(CLK)
- C4 Not used
- C5 Ground(GND)
- C6 RFU²
- C7 Input/output(I/O)
- C8 Not used

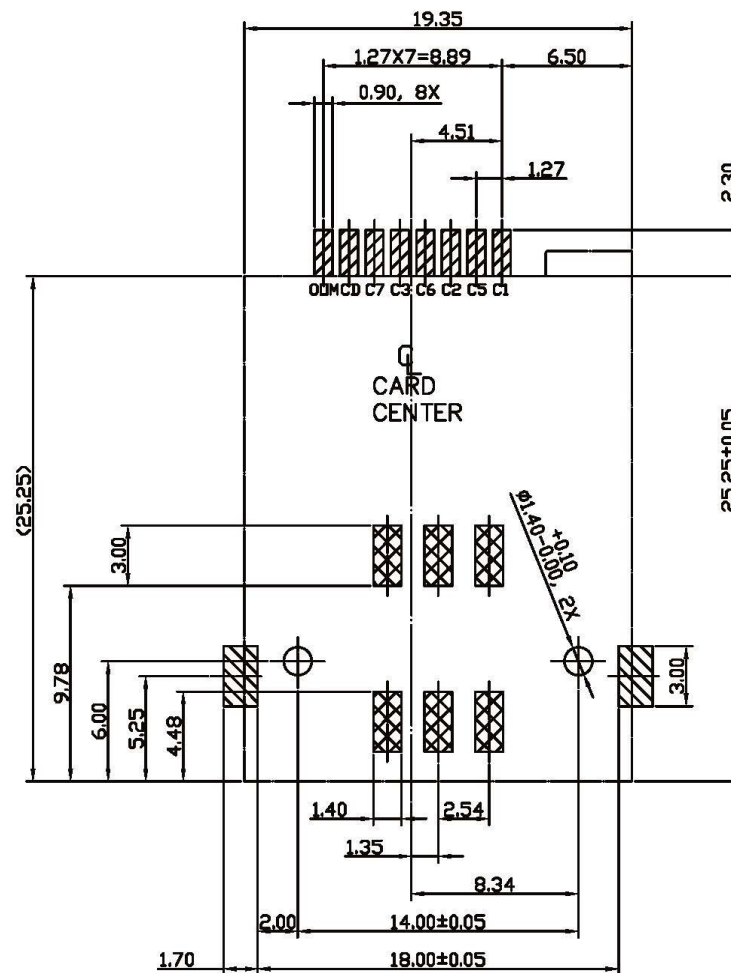

RECOMMENDED PCB LAYOUT

 — TRACR PROHIBITION AREA

All Connectors

www.allconnectors.de info@allconnectors.de
Tel.: 0049 711 7009503 Fax: 0049 711 7009504
70794 Filderstadt - Germany Kettenerstr. 25

RoHS Compliant

DRAWING BY CY
CHECKED BY GENIUS
UNIT/ mm SCALE 1 : 1
DATE
SIZE A4 PROJECTION 

TOLERANCES ARE

X ± 0.30
X ± 0.30
XX ± 0.20
XXX ± 0.20
ANG ± 1°



ORDER INFORMATION

SCP-W14PBA08R-06-LF
SERIES 90°SMT POST TO POST 14.0mm B TYPE PUSH PUSH
LEADFREE REEL 06WAY EAR/POST 0.75mm

DESCRIPTION:

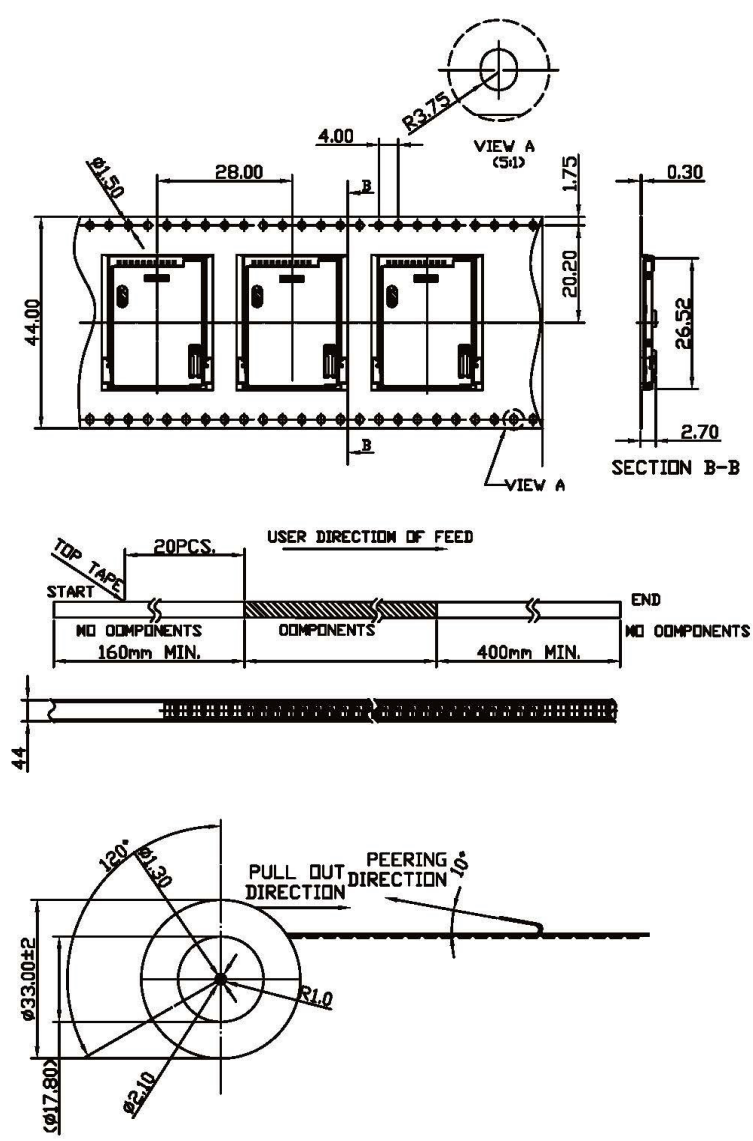

NOTE:
 1. STANDARD PACKING: 500 PCS/REEL
 2. 5 REEL/SHIPPING CARTON

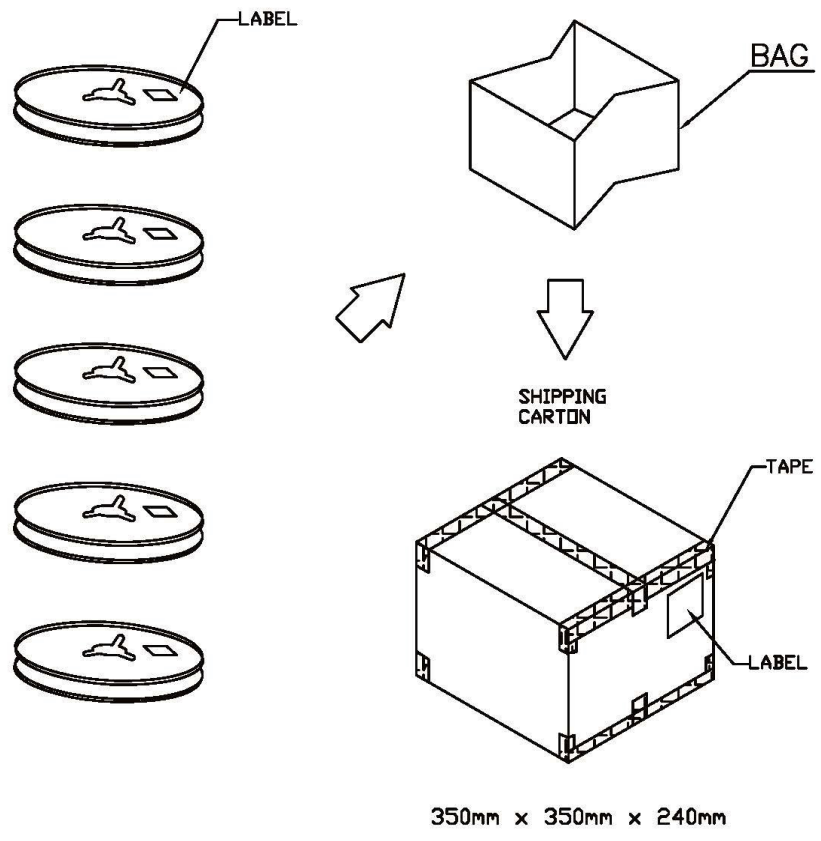

RoHS Compliant

All Connectors

www.allconnectors.de
 Tel.: 0049 711 7009503
 70794 Filderstadt - Germany

info@allconnectors.de
 Fax: 0049 711 7009504
 Kettenerstr. 25

TOLERANCES ARE

X ± 0.30
 .X ± 0.30
 .XX ± 0.20
 .XXX ± 0.20
 ANG ± 1°

DRAWING BY CY
CHECKED BY GENIUS

UNIT/ mm **SCALE 1 : 1**

DATE **SIZE A4** **PJECTION**



ORDER INFORMATION

SCP-W14PBA08R-06-LF

SERIES 90°SMT POST TO POST 14.0mm B TYPE EAR/POST 0.75mm REEL 06WAY LEADFREE PUSH PUSH

DESCRIPTION: