

- NOTES :
- MATERIAL : HIGH TEMPERATURE THERMOPLASTIC , UL94V-0.  
COLOR : BLACK  
CONTACT : PHOSPHOR BRONZE.
  - PLATING :  
CONTACT AREA : Gold Flash Plated OVER Ni  
SOLDER AREA : Tin Plated OVER Ni

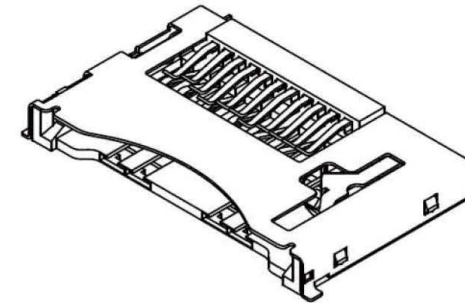

MHC-W21-401-LF  
LEADFREE  
RoHS Compliant

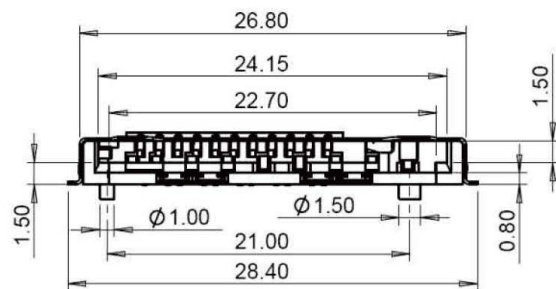

CIRCUIT:

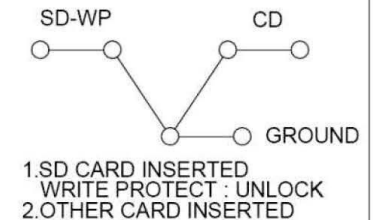
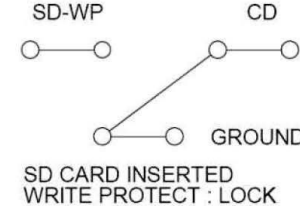
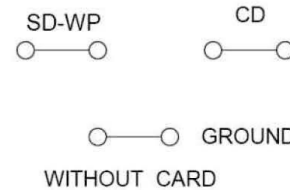

**Allconnectors**  
www.allconnectors.de  
Tel.: 0049 711 7009503  
70794 Filderstadt - Germany

info@allconnectors.de  
Fax: 0049 711 7009504  
Kettnerstr. 25

**RoHS Compliant**

DRAWING BY CY	
CHECKED BY GENIUS	
UNIT/ mm	SCALE 1 : 1
DATE	
SIZE A4	PPOJECTION

TOLERANCES ARE

- X. ±
- .X ±
- .XX ±
- .XXX ±
- ANG ±

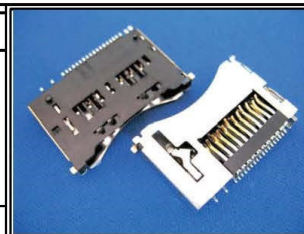

ORDER INFORMATION

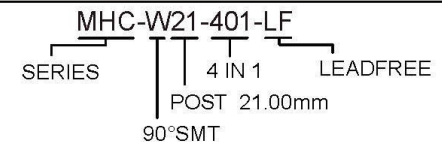

DESCRIPTION: 4 IN 1 (SD&MINI SD&MMC&RS-MMC)CARD COBECTOR

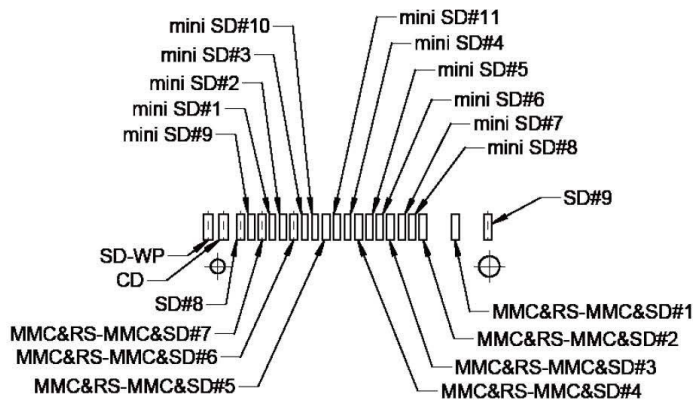

GROUND X2  
PCB LAYOUT

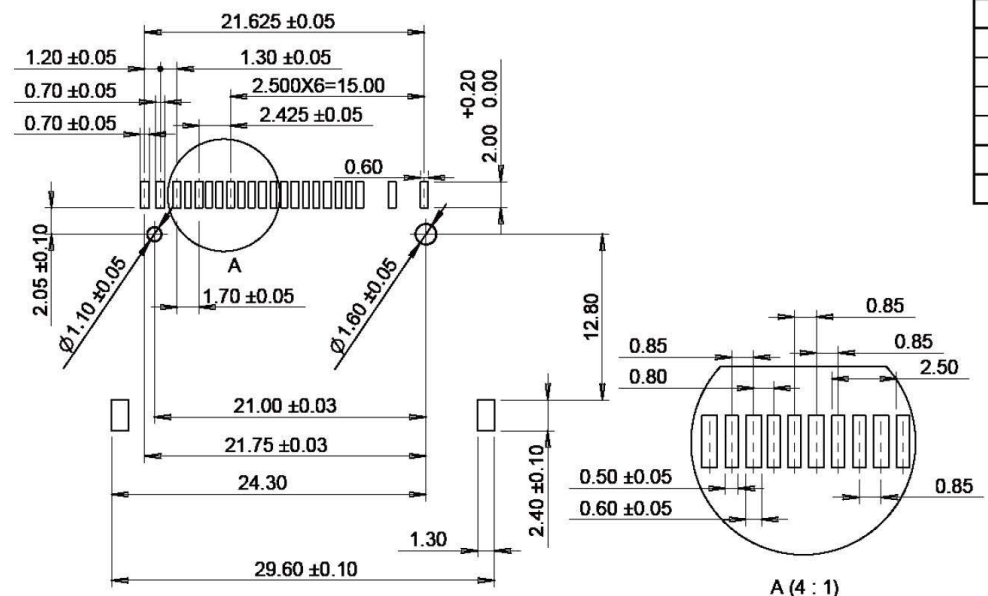

PCB LAYOUT

PIN ASSIGNMENT:

PIN NO.	MEMORY CARD PIN NO.
MMC&RS-MMC/SD#1	MMC&RS-MMC/SD-1 (RSV/DAT3)
MMC&RS-MMC&SD#2	MMC&RS-MMC&SD-2 (CMD)
MMC&RS-MMC&SD#3	MMC&RS-MMC&SD-3 (GND)
MMC&RS-MMC&SD#4	MMC&RS-MMC&SD-4 (VCC)
MMC&RS-MMC&SD#5	MMC&RS-MMC&SD-5 (CLK)
MMC&RS-MMC&SD#6	MMC&RS-MMC&SD-6 (GND)
MMC&RS-MMC&SD#7	MMC&RS-MMC&SD-7 (DAT0)
SD#8	SD-8 (DAT1)
SD#9	SD-9 (DAT2)
miniSD#1	miniSD-1 (CD/DAT3)
miniSD#2	miniSD-2 (CMD)
miniSD#3	miniSD-3 (GND)
miniSD#4	miniSD-4 (VCC)
miniSD#5	miniSD-5 (CLK)
miniSD#6	miniSD-6 (GND)
miniSD#7	miniSD-7 (DAT0)
miniSD#8	miniSD-8 (DAT1)
miniSD#9	miniSD-9 (DAT2)
miniSD#10	miniSD-10 (NC)
miniSD#11	miniSD-11 (NC)

**Allconnectors**

www.allconnectors.de  
Tel.: 0049 711 7009503  
70794 Filderstadt - Germany

info@allconnectors.de  
Fax: 0049 711 7009504  
Kettnerstr. 25

**RoHS Compliant**

DRAWING BY CY		TOLERANCES ARE X ± .X ± 0.20 .XX ± 0.10 .XXX ± ANG ±
CHECKED BY GENIUS		
UNIT/ mm	SCALE 1 : 1	
DATE		
SIZE A4	PPOJECTION	

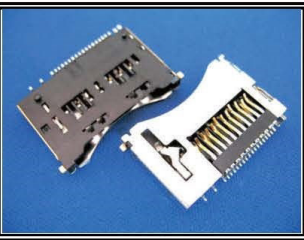

ORDER INFORMATION

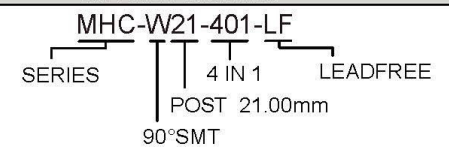

DESCRIPTION: 4 IN 1 (SD&MINI SD&MMC&RS-MMC)CARD COBBECTOR