

ORDERING INFORMATION

SERIES NO.	TYPE	ITEM	STAND OFF HEIGHT	CONTACT PLATING	OPTION
62	9	35	0	7	2
	9: Push-Push	35: 3.3-DIFF-24.0-L	0: 0mm	7: L/F Au 10u" SELECTIVE	2: PVC TRAY

NOTE:

- 1) Material:
 - Insulator: UL 94V-0 rated, LCP+30% G.F
 - Color : Black
 - Contact: Phosphor Bronze
- 2) Plating:
 - Contact Area: selective Gold plating over 1.2uM (50u")Nickel underplating.
 - Solder tail: 100u"Sn over 50u"Nickel underplating
- 3) Optional solder pad of metal latch
- 4) Pin assignment

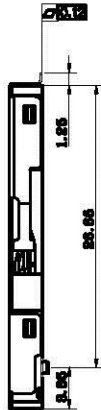
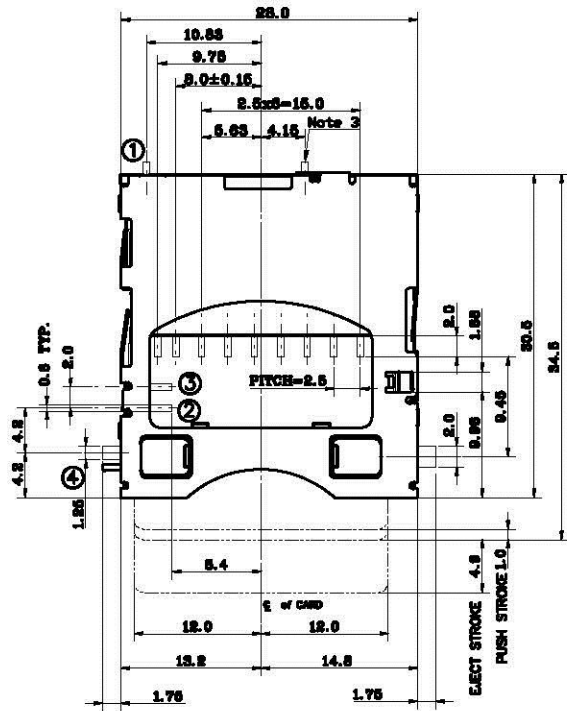

① CD

Note 3

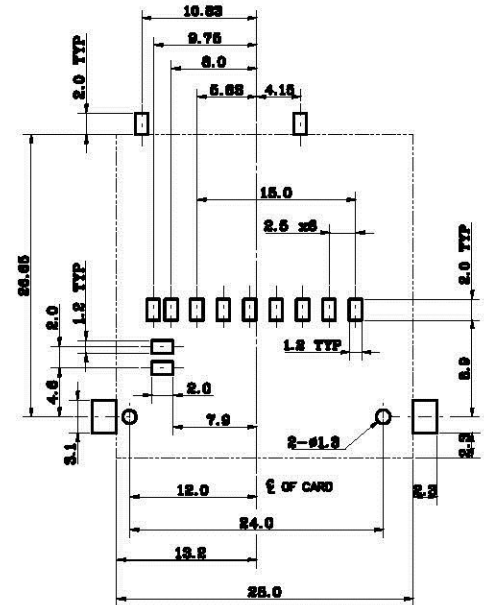
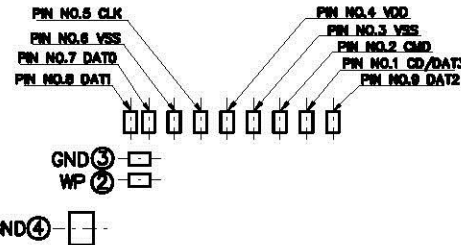

RECOMMENDED P.C.B. LAYOUT

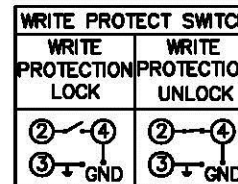
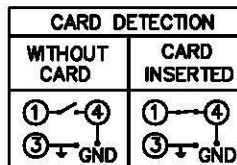
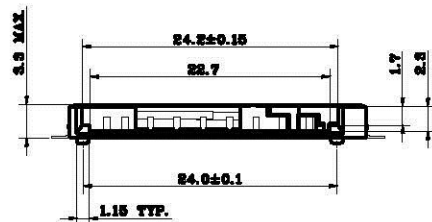

REV.	△	ECN 1010301	Artd	A.L	03/26/2012	GENERAL TOLERANCE	DIMENSION	ANGLES	All Connectors	APPROVED	ALBERT.LIU 04/10/05	TITLE:	SECURE DIGITAL MEMORY CARD
	△	ECN 971102	Artd	A.L	11/13/08					0.0 ±0.5	0° ±3°	CHECKED	JEFF .CHEN 04/10/05
	△	RELEASE	A.C	A.L	08/22/03	.00 ±0.3		DRAWN		CHIA MING CHANG 04/10/05	PART.NO:	62935072 (Lead Free)	
		DESCRIPTION(ECN No)	DR.	CHK.	DATE	SCALE:	N.S.T	UNIT:		mm	SIZE	A4	REV.

www.allconnectors.de
Tel: 0049 711 700590
70704 Mönchstett - Germany

Info@allconnectors.de
Tel: 0049 711 700504
Kettnerstr. 25