

TYPE	CONTACT NO.	L
DETECT	36,67	3.5
GENERAL	OTHERS	4.25
POWER	1,17,34,35,51,68	5.0

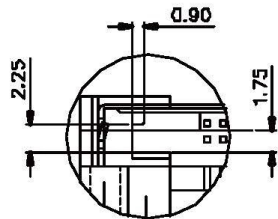

A VIEW  
S=2/1  
FOR 3.3 V

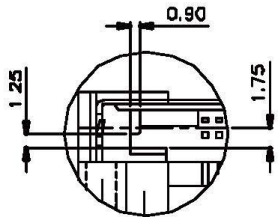

A VIEW  
S=2/1  
FOR 5.0 V

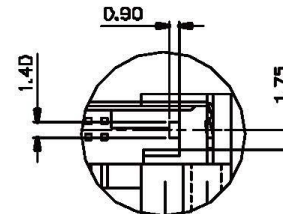
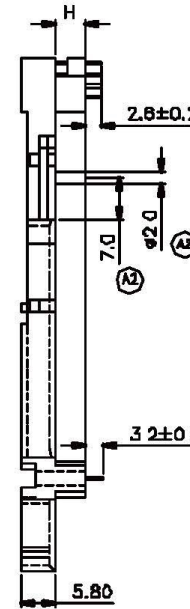
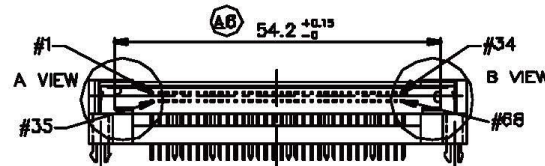
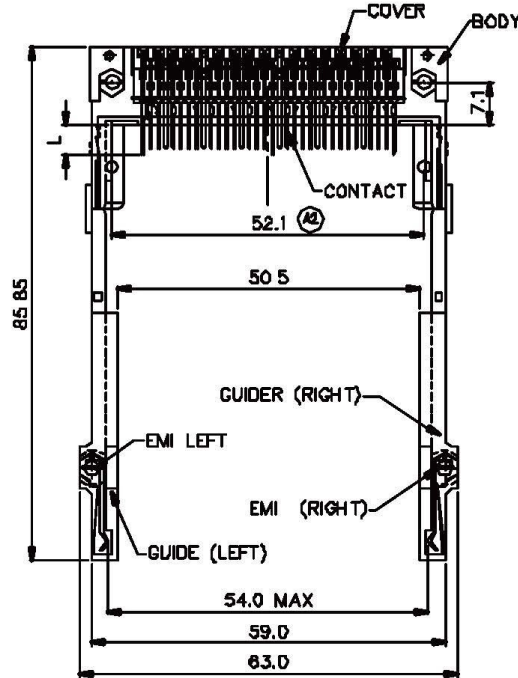

B VIEW  
S=2/1

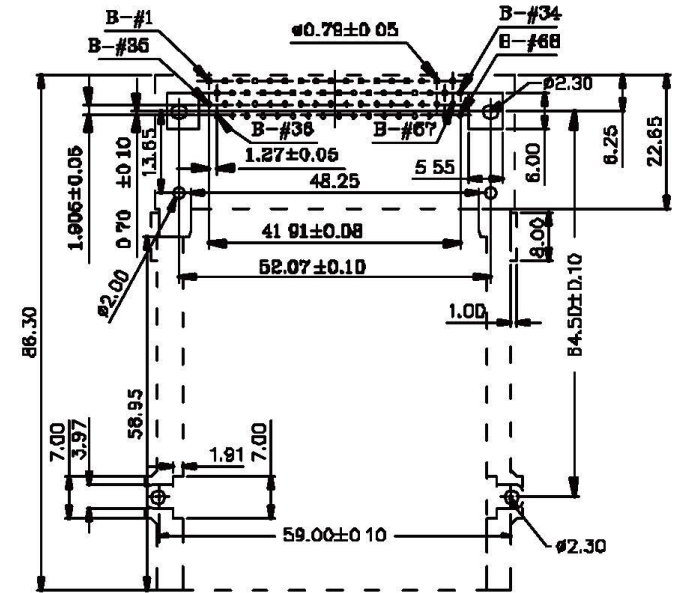

H	Dimension
00	0.00mm
20	2.00mm
28	2.80mm
40	4.00mm
50	5.00mm
80	8.00mm
22	2.20mm

RoHS Compliant

All Connectors

www.allconnectors.de info@allconnectors.de  
Tel.: 0049 711 7009503 Fax: 0049 711 7009504  
70794 Filderstadt - Germany Kettenerstr. 25

DRAWING BY CY	
CHECKED BY GENIUS	
UNIT / mm	SCALE 1:1
DATE	
SIZE A4	P PROJECTION

TOLERANCES ARE

X. ±  
.X ±  
.XX ±  
.XXX ±  
ANG ±



ORDER INFORMATION

PCC-PRLxxVxZ-68-LF



DESCRIPTION: PCMCIA CONNECTOR LONG TYPE WITH GUIDE RAIL