

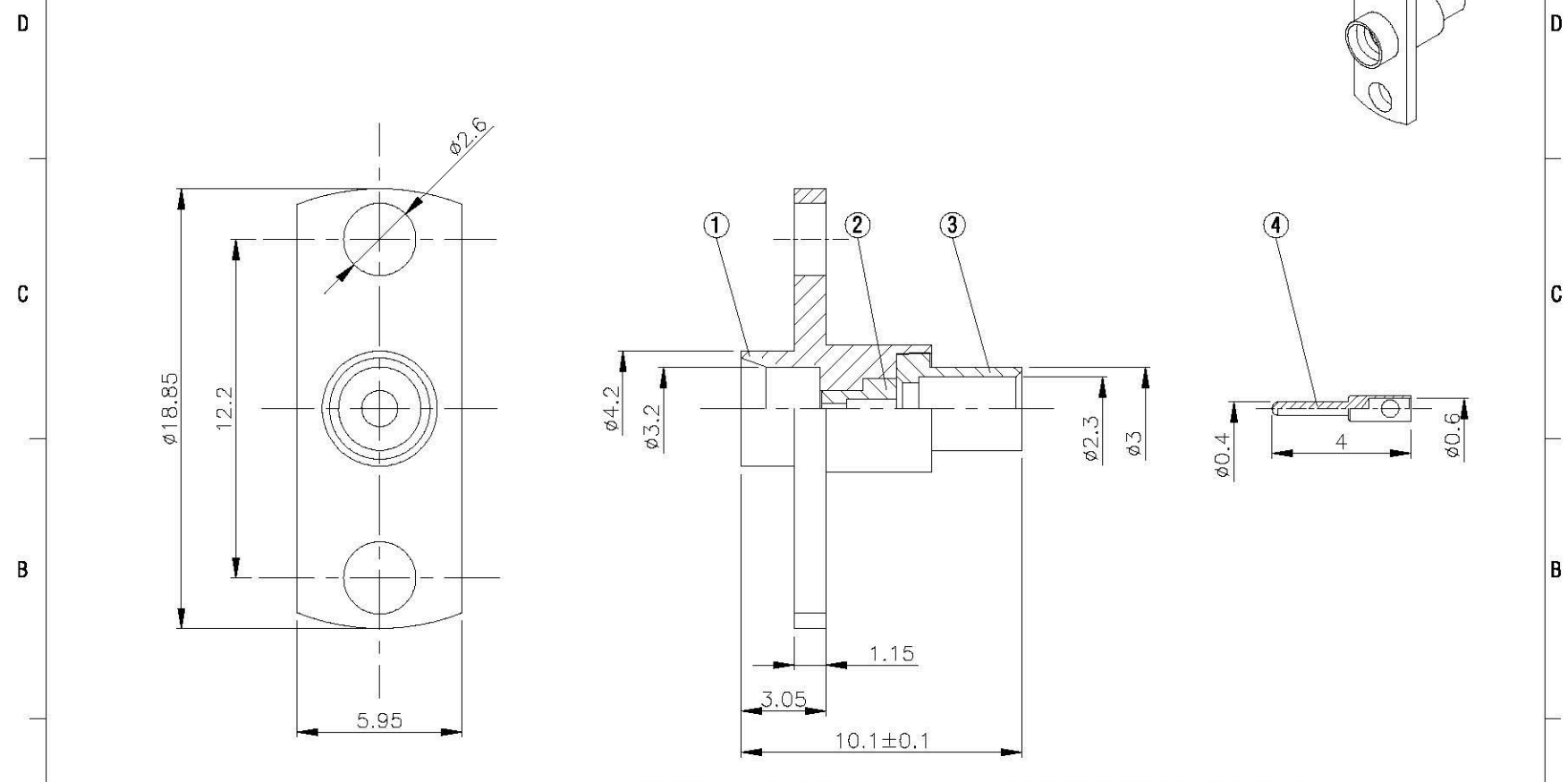

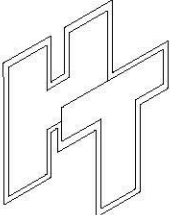



NO	DESCRIPTION	MATERIAL	Q'TY	FINISH	REMARK
1	BODY	SUS303	1	PASSIVATED	B-SMP1399-SUS
2	INSULATION	TEFLON	1	TEFLON	I-0033T
3	BODY	BRASS	1	GOLD	B-MCX0149-G
4	PIN	PH.BRONZE	1	GOLD	P-SMP0971-G



		DRAWN  DATE 08.04.14	DIMENSIONS ARE IN MILLIMETERS		REVISION	
	<small> 香港新界沙田大圍廣生街1號 Tel: 00852 211 7900/004 香港新界沙田大圍廣生街1號 Tel: 00852 211 7900/004 </small>	CHECKED  DATE	UNLESS OTHERWISE SPECIFIED TOLERANCE		DESCRIPTION	ENGINEER
	TITLE SMP FEMALE FLANGE MOUNT RG-405/U(.085")(CATCHERS MIT)	Q.A.  DATE	$0.5-5 = \pm 0.2$	$120-315 = \pm 1$		
	PART NO. SMP-22V1-TGSUS	APPROVAL  DATE	$5-30 = \pm 0.4$	$315-1000 = \pm 1.6$		
	DRAWING NO. SMP-22V1-TGSUS	REVISION DATE	$30-120 = \pm 0.6$	$1000-2000 = \pm 2.4$		
		SCALE 4:1	SIZE A			