

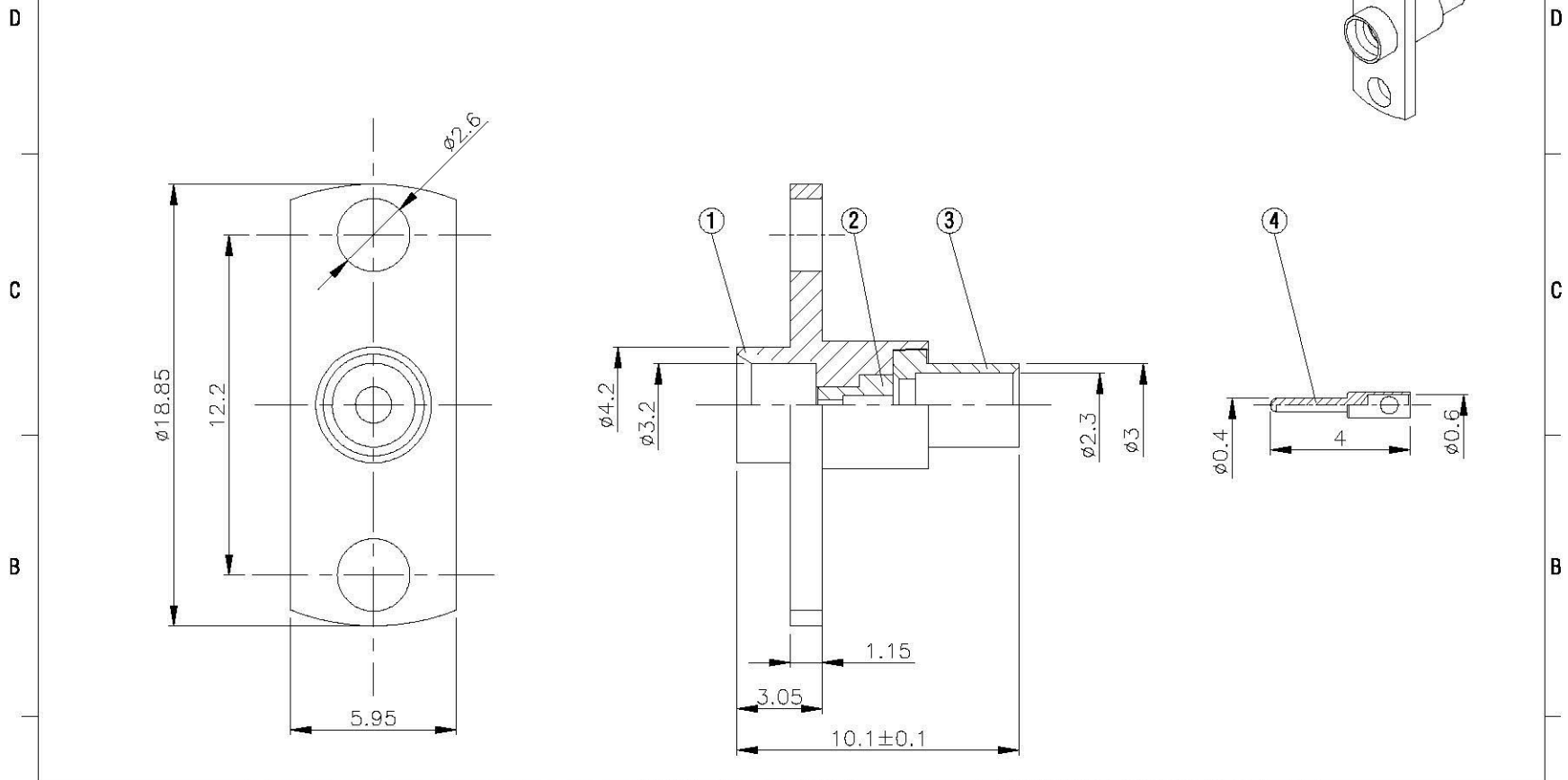

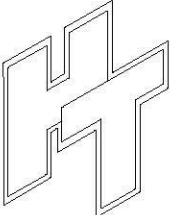



NO	DESCRIPTION	MATERIAL	Q'TY	FINISH	REMARK
1	BODY	SUS303	1	PASSIVATED	B-SMP-SUS
2	INSULATION	TEFLON	1	TEFLON	I-0033T
3	BODY	BRASS	1	GOLD	B-MCX0149-G
4	PIN	PH.BRONZE	1	GOLD	P-SMP0971-G



		DRAWN  DATE 99.04.14	DIMENSIONS ARE IN MILLIMETERS		REVISION		
	<small>www.allconnectors.de TEL: 0049 711 7000500 20199-11010101-1 Germany</small>	<small>info@allconnectors.de TEL: 0049 711 7000501 Koblenzstr. 22</small>	CHECKED  DATE	UNLESS OTHERWISE SPECIFIED TOLERANCE		DESCRIPTION	ENGINEER
	TITLE SMP FEMALE FLANGE MOUNT RG-405/U(.085")(SMOOTH BORE)	Q.A.  DATE	0.5-5 = ± 0.2	120-315 = ± 1			
	PART NO. SMP-22V1-TGSUS-3	APPROVAL  DATE	5-30 = ± 0.4	315-1000 = ± 1.6			
	DRAWING NO. SMP-22V1-TGSUS-3	REVISION DATE	30-120 = ± 0.6	1000-2000 = ± 2.4			
		SCALE 4:1	SIZE A				