

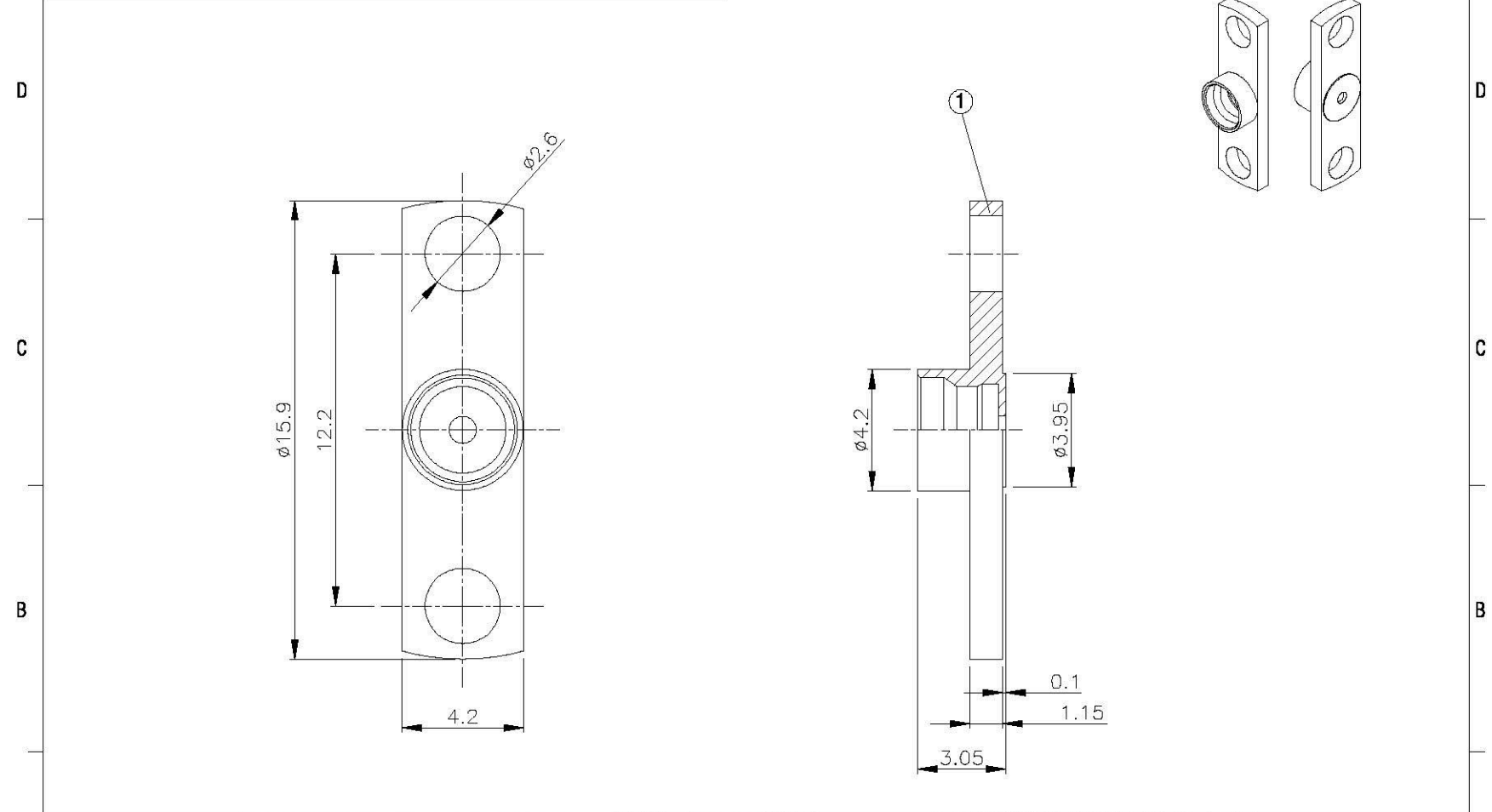

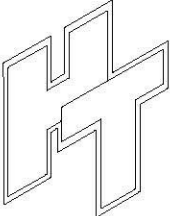



NO	DESCRIPTION	MATERIAL	Q'TY	FINISH	REMARK
1	BODY	SUS303	1	PASSIVATED	B-SMP1390-SUS



		DRAWN		DATE	98.03.20	DIMENSIONS ARE IN MILLIMETERS			REVISION	
	<small>www.allconnectors.de Tel: +49 7141 9094-0 70754 Hildesheim, Germany</small>	CHECKED		DATE		UNLESS OTHERWISE SPECIFIED TOLERANCE			DESCRIPTION	ENGINEER
	<b>TITLE</b> SMP MALE FLANGE MOUNT SHROUD LIMITED DETENTE	Q.A.		DATE		0.5-5=±0.2	120-315=±1			
	<b>PART NO.</b> SMP-21-SUS-1	APPROVAL		DATE		5-30=±0.4	315-1000=±1.6			
	<b>DRAWING NO.</b> SMP-21-SUS-1	REVISION		DATE		30-120±0.6	1000-2000=±2.4			
					SCALE	4:1	SIZE	A		