

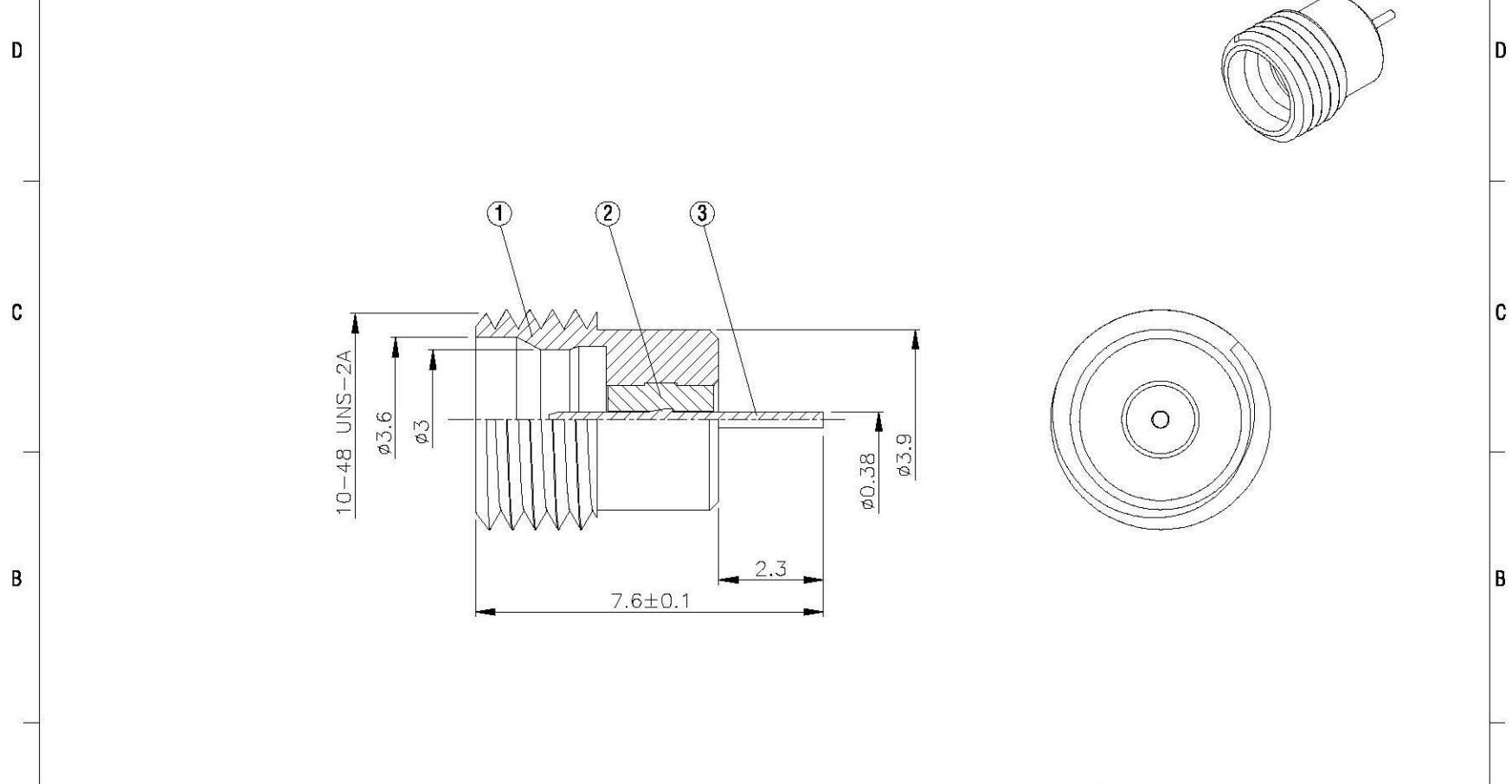

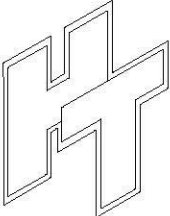



NO	DESCRIPTION	MATERIAL	Q'TY	FINISH	REMARK
1	BODY	SUS303	1	PASSIVATED	B-SMP-SUS
2	INSULATION	TEFLON	1	TEFLON	I-0181T
3	PIN	PH.BRONZE	1	GOLD	P-SMP0245-G



	 <small>www.allconnectors.de Tel. +49 410 211 100-10 20091 Meldorf - Germany</small> <small>info@allconnectors.de Fax: +49 410 211 100-20 kapitel@allconnectors.de</small>	DRAWN 	DATE 98.07.29	DIMENSIONS ARE IN MILLIMETERS		REVISION	
	TITLE SMP MALE THREAD-IN (FULL DETENT)	CHECKED 	DATE	UNLESS OTHERWISE SPECIFIED TOLERANCE		DESCRIPTION	ENGINEER
	PART NO. SMP-20-TGSUS-1	Q.A. 	DATE	0.5-5=±0.2	120-315=±1		
	DRAWING NO. SMP-20-TGSUS-1	APPROVAL 	DATE	5-30=±0.4	315-1000=±1.6		
		REVISION	DATE	30-120±0.6	1000-2000=±2.4		
			SCALE	4:1	SIZE	A	

4 3 2 1