

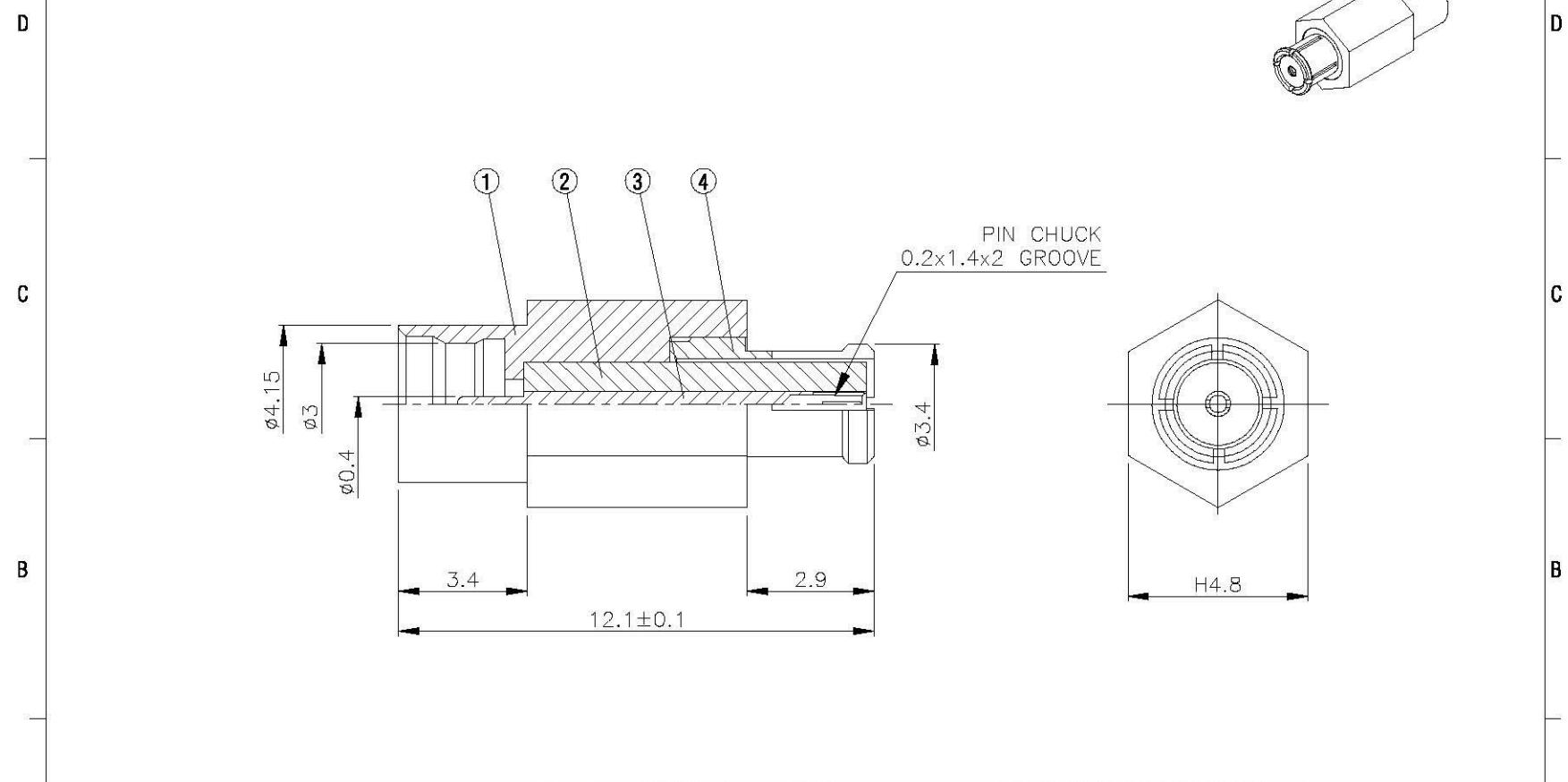

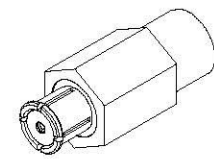

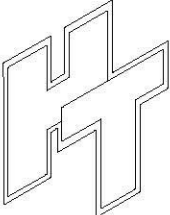

NO	DESCRIPTION	MATERIAL	Q'TY	FINISH	REMARK
1	BODY 1	SUS303	1	PASSIVATED	B-SMP1447-SUS
2	INSULATION 1	TEFLON	1	TEFLON	I-0561T
3	PIN	BE CU	1	GOLD	P-SMP0944-G
4	BODY 2	BE CU	1	GOLD	B-SMP1364-G



	 <small>www.allconnectors.de info@allconnectors.de</small> <small>Tel: +0049 711 7006683 Fax: +0049 711 7006694</small> <small>Postfach 1220001 40101 Germany Krefeld, Germany</small>	DRAWN 	DATE 98.07.27	DIMENSIONS ARE IN MILLIMETERS			REVISION	
	TITLE SMP MALE - SMP FEMALE ADAPTOR (FULL DETENT)	CHECKED 	DATE	UNLESS OTHERWISE SPECIFIED TOLERANCE			DESCRIPTION	ENGINEER
	PART NO. SMP-19-TGSUS-1	Q.A. 	DATE	0.5-5=±0.2	120-315=±1			
	DRAWING NO. SMP-19-TGSUS-1	APPROVAL 	DATE	5-30=±0.4	315-1000=±1.6			
		REVISION	DATE	30-120=±0.6	1000-2000=±2.4			
			SCALE	4:1	SIZE	A		