

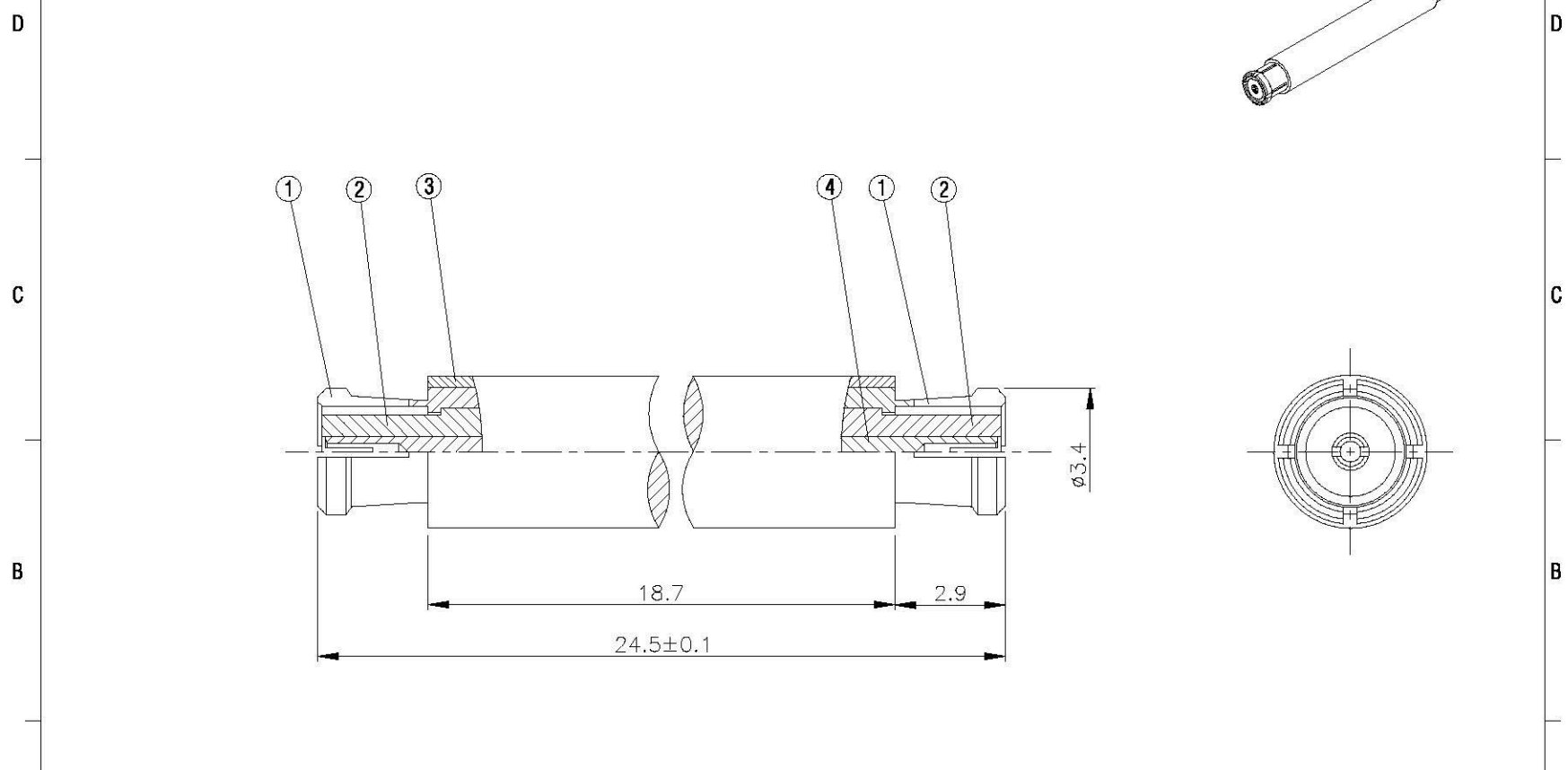

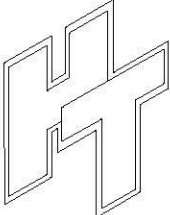



NO	DESCRIPTION	MATERIAL	Q'TY	FINISH	REMARK
1	BODY	BE CU	2	GOLD	B-SMP1364-G
2	INSULATION	TEFLON	2	TEFLON	I-0641T
3	BODY 2	BRASS	1	GOLD	B-SMP1372-G
4	PIN	BE CU	1	GOLD	P-SMP0938-G



	 <small>www.allconnectors.de Tel: 0912 731 70000 70770 Filberstadt - Germany</small> <small>an Digital Components Ltd Tel: 0912 731 70000 Ballwinstr. 25</small>	DRAWN 	DATE 97.11.26	DIMENSIONS ARE IN MILLIMETERS				REVISION	
		CHECKED 	DATE	UNLESS OTHERWISE SPECIFIED TOLERANCE				DESCRIPTION	ENGINEER
	TITLE SMP FEMALE -FEMALE ADAPTOR Nonimal Board-to-Board Distance	Q.A. 	DATE	0.5-5=±0.2	120-315=±1				
	PART NO. SMP-05V10-TGG	APPROVAL 	DATE	5-30=±0.4	315-1000=±1.6				
	DRAWING NO. SMP 05V10 TGG	REVISION	DATE	30-120±0.6	1000-2000=±2.4	SCALE	4:1	SIZE	A