

NO	DESCRIPTION	MATERIAL	Q'TY	FINISH
1	BODY 1	BRASS	1	GOLD
2	INSULATION	TEFLON	1	TEFLON
3	BODY 2	BRASS	1	GOLD
4	PIN	BRASS	1	GOLD
5	WASHER	BRASS	1	GOLD
6	NUT	BRASS	1	GOLD

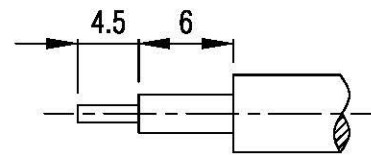

(Recommended Stripping Dimension)

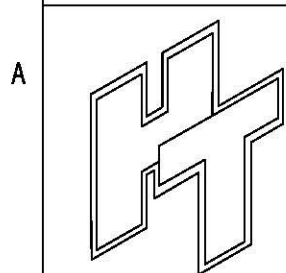
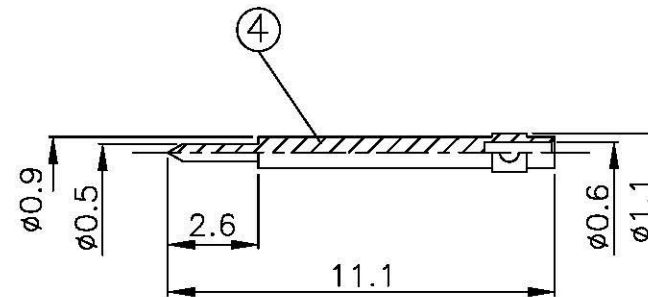
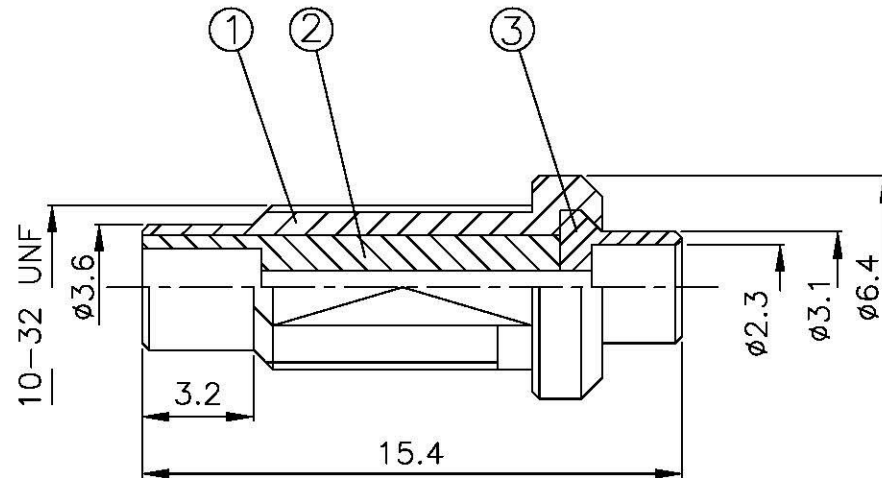
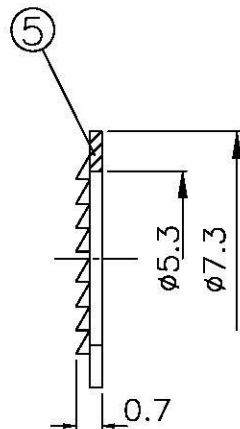
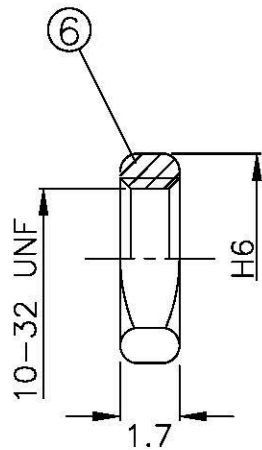
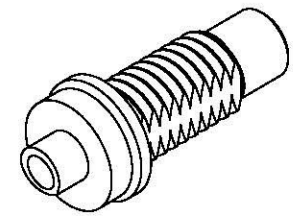

**All Connectors**  
 www.allconnectors.com    info@allconnectors.com  
 TEL: 0049 711 2005071    FAX: 0049 711 2005040  
 20231 Mittelstraße 11 - Germany    20231 Mittelstraße 11, Germany

TITLE SMC PLUG BULKHEAD FOR  
 RG405U (.085)

PART NO. SMC-01V1-TGG

DRAWING NO. SMC 01V1 TGG

DRAWN MARY

DATE 87.04.02

CHECKED 黄巧君

DATE 96.02.13

Q.A. 蘇姿潔

DATE

APPROVAL 徐燦霖

DATE

REVISION

DATE

DIMENSIONS ARE IN MILLMETERS

UNLESS OTHERWISE SPECIFIED  
 TOLERANCES

0.5-5 = ±0.2	120-315 = ±1
5-30 = ±0.4	315-1000 = ±1.6
30-120 = ±0.6	1000-2000 = ±2.4

SCALE 4:1    SIZE A

REVISION

DESCRIPTION	ENGINEER