

ROHS Compliant



# All Connectors

www.allconnectors.de  
Tel.: 0049 711 7009503  
70794 Filderstadt - Germany

info@allconnectors.de  
Fax: 0049 711 7009504  
Kettenerstr. 25

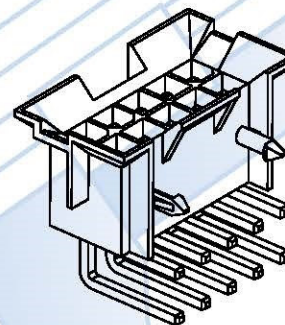
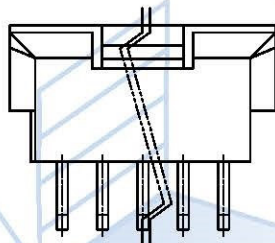
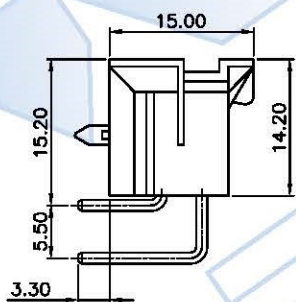
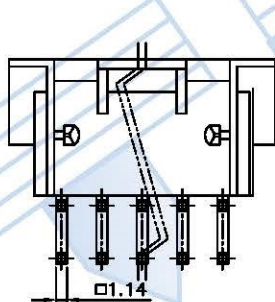
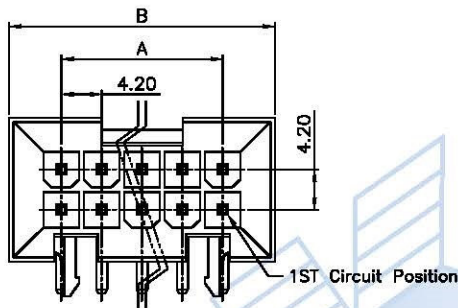

- NOTE :**
- \* Material : Nylon UL 94V-0
  - \* Contact : Brass
  - \* Color : White
  - \* Electrical rating : TUV 250V 7A , AC/DC
  - \* Used in H6658R Series housings
  - \* housings series : Dual row
  - \* Dual row , 6-36 circuits available

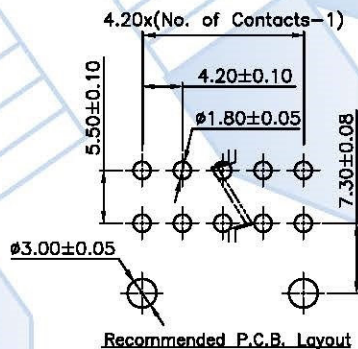
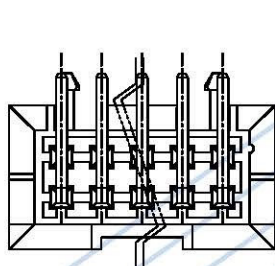

**ENTWURF**

Circuits	Part No.	Dim. A	Dim. B	Circuits	Part No.	Dim. A	Dim. B
6	P6658L-06	8.40	19.30	24	P6658L-24	46.20	57.10
8	P6658L-08	12.00	23.50	26	P6658L-26	50.40	61.30
10	P6658L-10	16.80	27.70	28	P6658L-28	54.60	65.50
12	P6658L-12	21.00	31.90	30	P6658L-30	58.80	69.70
14	P6658L-14	25.20	36.10	32	P6658L-32	63.00	73.90
16	P6658L-16	29.40	40.30	34	P6658L-34	67.20	78.10
18	P6658L-18	33.60	44.50	36	P6658L-36	71.40	82.30
20	P6658L-20	37.80	48.70	38	P6658L-38	75.60	86.50
22	P6658L-22	42.00	52.90	40	P6658L-40	79.80	90.70

TUV  
R50085738

PART NO.	P6658L-XX			Part NO.	Material	Finish	Remark	APPROVAL
TITLE	4.20mm Wire to Wire			P6658L-XX	Nylon UL 94V-0	Plated Gold		DRAWN: <b>ENTWURF</b>
THIRD ANGLE	SCALE	UNIT	SHEET NO	P6658L-XXS	Nylon UL 94V-0	Plated Tin		CHECKED: <b>ENTWURF</b>
	1.25:1	mm	1/1	TOLERANCE	DATE	ODD NUMBERS	REV	APPROVED: <b>ENTWURF</b>
	420-053		C420-012	.X± 0.30 .XXX±0.10 .XX± 0.20 ANGLE±2'	2008.1.16	ENG950007	A1	