

(2 to 9 circuits)

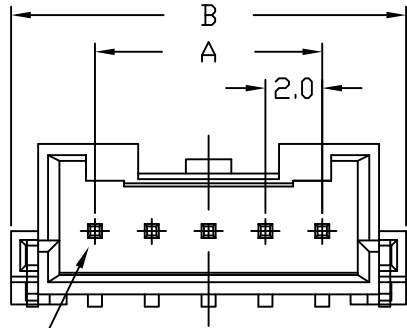

Circuit No.1

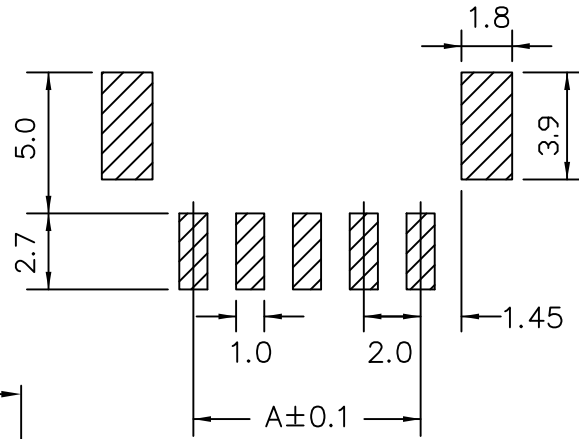
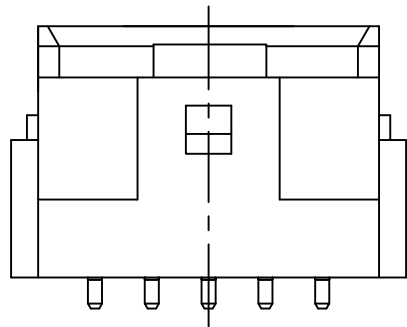
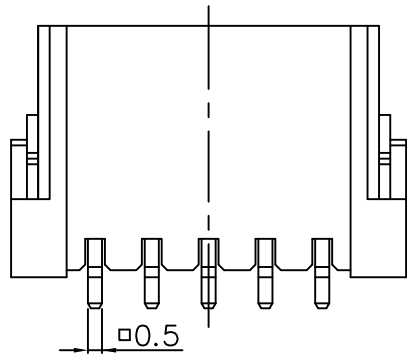

RECOMMENDED P.C.BOARD LAYOUT DIMM.

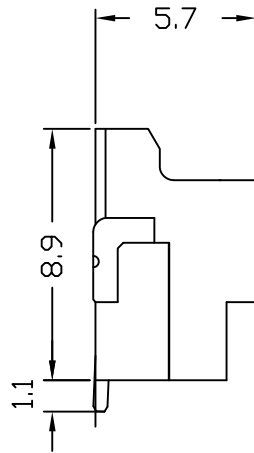

Specifications

Current Rating: 3A AC/ DC (Max)AWG#22
 Voltage Rating: 250V AC/ DC
 Temperature Range: -25°C ~ + 85°C
 Contact Resistance: 20mΩ Max
 Insulation Resistance: 1000MΩ Min
 Withstanding Voltage:800V AC/Minute
 Pin : Brass/ Tin-plated/ Gold-flash
 Wafer Material: Nylon 6T,UL94V-0,natural
 Solder tab:Brass/Tin-plated

Poles	Dimension mm (in.)		Part No.
	A	B	
2	2.0(0.079)	8.0(0.315)	PA-WX-02
3	4.0(0.157)	10.0(0.394)	PA-WX-03
4	6.0(0.236)	12.0(0.472)	PA-WX-04
5	8.0(0.315)	14.0(0.551)	PA-WX-05
6	10.0(0.394)	16.0(0.630)	PA-WX-06
7	12.0(0.472)	18.0(0.709)	PA-WX-07
8	14.0(0.551)	20.0(0.787)	PA-WX-08
9	16.0(0.630)	22.0(0.866)	PA-WX-09

PA-WX-xx-LF
 LEADFREE

RoHS Compliant

PART NO. PA-WX-xx

DWG NO. PA-WX-xx

FILE NO.

UNIT / mm

SCALE 1:1

CHECKED BY CY

DRAWING BY

PROJECTION

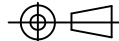

TOLERANCES ARE

.X ± 0.2

.XX ±

.XXX ±

AWG

DESCRIPTION:

2.0mm Wire-to-Board Header
 SMD 90° Type

AREA

REVISIONS

HK

DATE

Allconnectors

www.allconnectors.eu | info@allconnectors.eu
 Tel. +49 (0)711 / 358 110 20 | Fax +49 (0)711 / 358 110 25

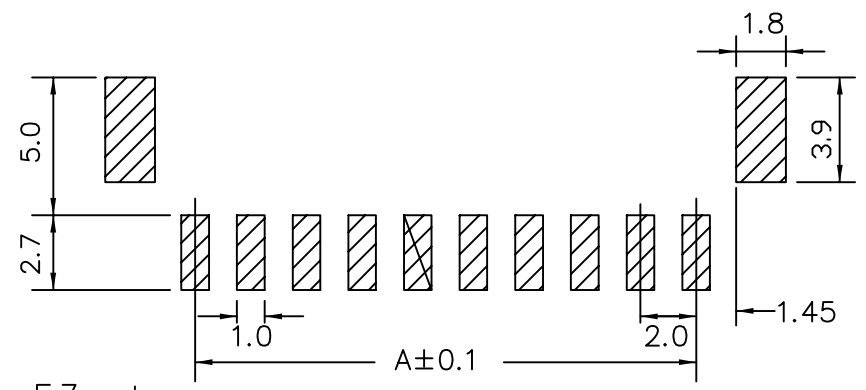
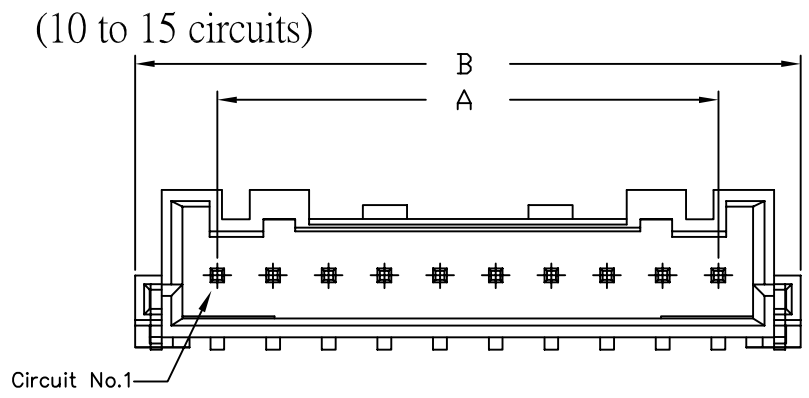

RECOMMENDED P.C.BOARD LAYOUT DIMM.

Specifications

- Current Rating: 3A AC/ DC (Max)AWG#22
- Voltage Rating: 250V AC/ DC
- Temperature Range: -25°C ~ + 85°C
- Contact Resistance: 20mΩ Max
- Insulation Resistance: 1000MΩ Min
- Withstanding Voltage:800V AC/Minute
- Pin : Brass/ Tin-plated/ Gold-flash
- Wafer Material: Nylon 6T,UL94V-0,natural
- Solder tab:Brass/Tin-plated

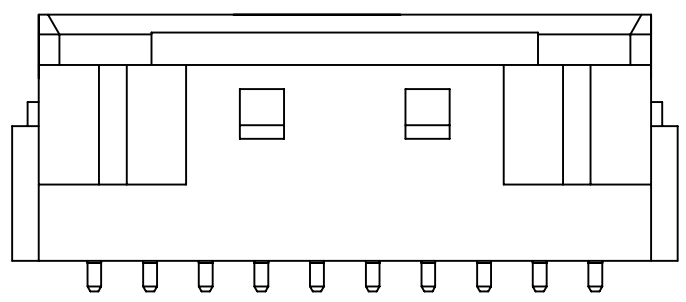
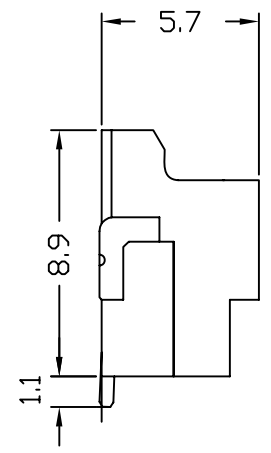
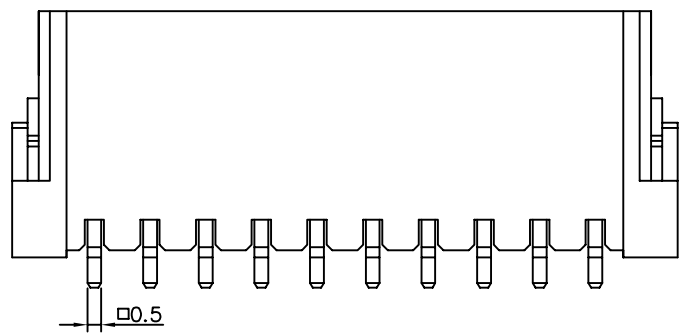

Poles	Dimension mm (in.)		Part No.	Note.
	A	B		
10	18.0(0.709)	24.0(0.945)	PA-WX-10	
11	20.0(0.787)	26.0(1.024)	PA-WX-11	
12	22.0(0.866)	28.0(1.102)	PA-WX-12	
13	24.0(0.945)	30.0(1.181)	PA-WX-13	
14	26.0(1.024)	32.0(1.260)	PA-WX-14	
15	28.0(1.102)	34.0(1.338)	PA-WX-15	

PART NO. PA-WX-xx		CHECKED BY CY		TOLERANCES ARE .X ± 0.2 .XX ± .XXX ± AWG	DESCRIP TION: 2.0mm Wire-to-Board Header SMD 90° Type
DWG NO. PA-WX-xx		DRAWING BY			
FILE NO.		PROJECTION		AREA	REVISIONS
UNIT / mm	SCALE 1:1			HK	DATE