

NOTE :

- * Material : Nylon UL 94V-0
- * Standard color : Black
- * Electrical rating : 600V 50A ,AC/DC
- * 2-6 circuits available

Circuits	Part No.	Dim. A	Dim. B
2	MFS-PH-1X02	10.00	31.30
3	MFS-PH-1X03	20.00	41.30
4	MFS-PH-1X04	30.00	51.30
5	MFS-PH-1X05	40.00	61.30
6	MFS-PH-1X06	50.00	71.30

MFS-PH-1Xxx-LF
LEADFREE
RoHS Compliant

Allconnectors
www.allconnectors.de
Tel.: 0343 711 700503
70704 Filderstadt - Germany

info@allconnectors.de
Fax: 0343 711 700504
Kettenstr. 25

PART NO. MFS-PH-1Xxx

DWG NO. MFS-PH-1Xxx

FILE NO.

UNIT / mm

SCALE 1:1

CHECKED BY CY

DRAWING BY

PROJECTION

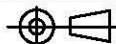

TOLERANCES ARE

.X ± 0.2
.XX ±
.XXX ±
AWG

DESCRIPTION:

AREA

REVISIONS

HK

DATE

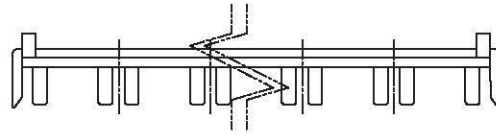
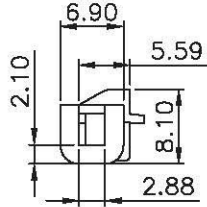
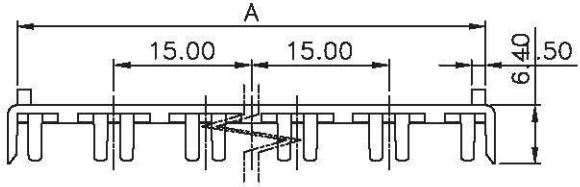
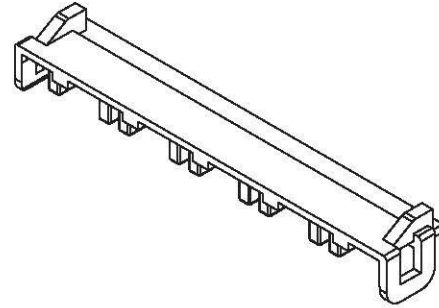
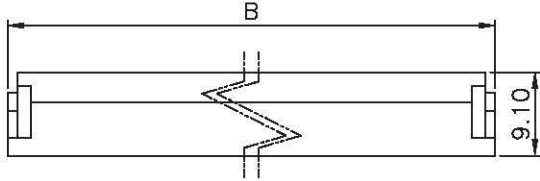

NOTE :
 * Material : Nylon UL 94V-0
 * Standard color : Black
 * 2-6 circuits available

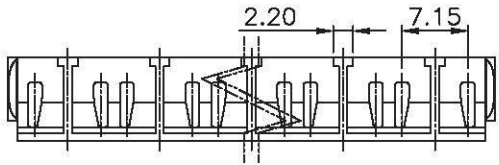

Circuits	Dim. A	Dim. B
2	21.00	23.10
3	31.00	33.10
4	41.00	43.10
5	51.00	53.10
6	61.00	63.10

All connectors

www.allconnectors.de
 Tel.: 0049 711 7009303
 70734 Filderstadt - Germany

info@allconnectors.de
 Fax: 0049 711 7009508
 Kettnerstr. 25

PART NO. MFS-PH-1Xxx

DWG NO. MFS-PH-1Xxx

FILE NO.

UNIT / mm

CHECKED BY CY

DRAWING BY

SCALE 1:1

PROJECTION

TOLERANCES ARE
 X ±
 .X ± 0.30
 .XX ± 0.20
 .XXX ± 0.10
 ANG

DESCRIPTION:

10.00mm Wire to Board

AREA	REVISIONS	DATE