

This document is the property of Targ Yu Enterprise and is delivered on the express condition that it is not to be disclosed, reproduced or used, in whole or in part, for manufacture or sale by anyone other than Targ Yu Enterprise without its prior consent, and that no right is granted to disclose or to use any information in this document.

# Engineer Drawing

REV	ECN NO.	DESCRIPTION	DATE	APP'D
A/3	N/A	ADD PACKING SPECIFICATION	10/15/13	Paul
A/4	ECN-EN-2014014	UPDATE DRAWING	03/11/14	Paul
A/5	ECN-EN-2014029	AMEND PACKING	04/28/14	Paul

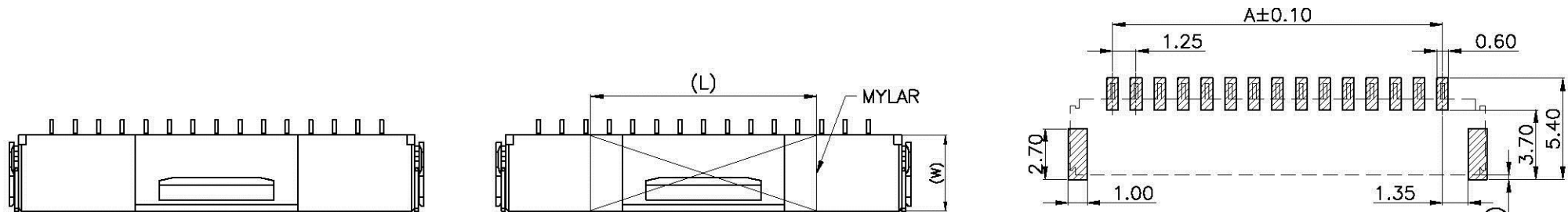

PICK AND PLACE AREA WITH MYLAR

TOLERANCE: ±0.05  
RECOMMENDED P.C.B. Layout TOP VIEW

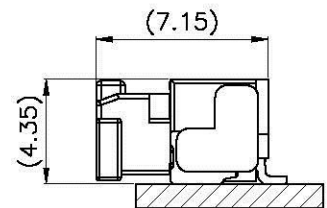
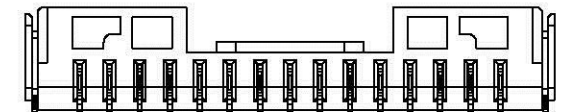
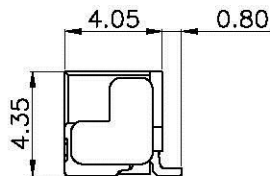
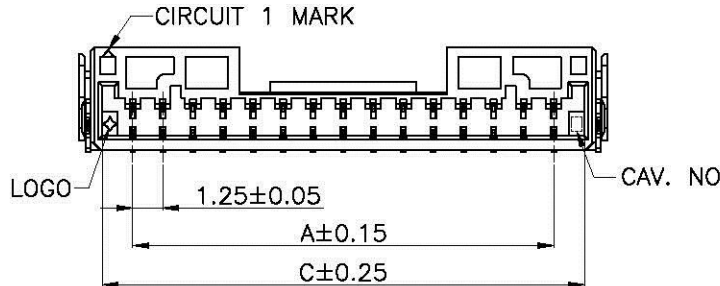

Mating Condition (REF.)

PIN	DIM.(mm)			MYLAR	PIN	DIM.(mm)			MYLAR
	A	B	C			A	B	C	
02	5.75	3.80	L6.00*W4.00*0.08	9	10.00	14.50	12.55	L10.00*W4.00*0.08	
03	2.50	7.00	L6.00*W4.00*0.08	10	11.25	15.75	13.80	L14.00*W4.00*0.08	
04	3.75	8.25	L7.50*W4.00*0.08	11	12.50	17.00	15.05	L14.00*W4.00*0.08	
05	5.00	9.50	L7.50*W4.00*0.08	12	13.75	18.25	16.30	L14.00*W4.00*0.08	
06	6.25	10.75	L10.00*W4.00*0.08	13	15.00	19.50	17.55	L14.00*W4.00*0.08	
07	7.50	12.00	L10.00*W4.00*0.08	14	16.25	20.75	18.80	L14.00*W4.00*0.08	
08	8.75	13.25	L10.00*W4.00*0.08	15	17.50	22.00	20.05	L14.00*W4.00*0.08	

- NOTES:
- MATERIAL  
INSULATION(HALOGEN FREE): NYLON, 9T UL94V-0 (BLACK)  
COVER(HALOGEN FREE): NYLON 9T, UL94V-0 (BLACK)  
CONTACT: COPPER ALLOY, t=0.20mm  
SOLDER TAB: COPPER ALLOY, t=0.20mm / MATTE-TIN PLATED OVER NICKEL
  - CONTACT FINISH: (VOID)--MATTE-TIN PLATED OVER NICKEL  
GO--GOLD FLASH OVER NICKEL  
G\*--GOLD \*u" OVER NICKEL
  - MATES WITH: TU1211 SERIES HOUSING
  - ORDERING CODE: TU1211WNR-1xNPSK-\*--NL-M-A



TOLERANCE	X.X ±0.25 X.XX ±0.15 ANGULA 3° UNLESS OTHERWISE SPECIFIED	APPROVALS	DATE	 www.allconnectors.de Tel.: 0049 711 7009503 20734 Eilendorf Germany	
		DRAWN <i>Suen Kong</i>	04/28/14'		
		CHK'D <i>Paul Chen</i>	04/28/14'	PART NO. TU1211WNR-1xNPSK-*--NL-M-A	TITLE: WIRE TO BOARD, WAFER, PITCH 1.25mm, RIGHT ANGLE, SMT TYPE, ASSEMBLY
		APP'D <i>Wayne Lai</i>	04/28/14'	DRAWING NO. EN-TU1211WNR-1xNPSK-*--NL-M-A	
		UNITS mm	SCALE 1:1	SIZE: A4	SHEET 1 OF 4

REV. A/5

This document is the property of Targ Yu Enterprise and is delivered on the express condition that it is not to be disclosed, reproduced or used, in whole or in part, for manufacture or sale by anyone other than Targ Yu Enterprise without its prior consent, and that no right is granted to disclose or to use any information in this document.

# Engineer Drawing

REV	ECN NO.	DESCRIPTION	DATE	APP'D
A/3	N/A	ADD PACKING SPECIFICATION	10/15/13	Paul
A/4	ECN-EN-2014014	UPDATE DRAWING	03/11/14	Paul
A/5	ECN-EN-2014029	AMEND PACKING	04/28/14	Paul

02P

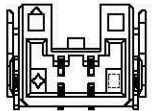

03P

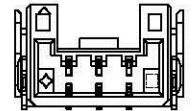

04P

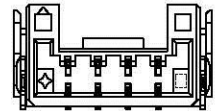

05P

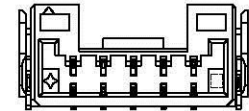

06P

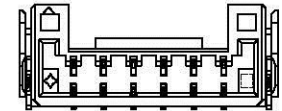

07P

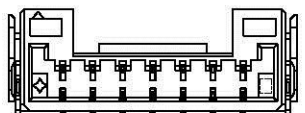

08P

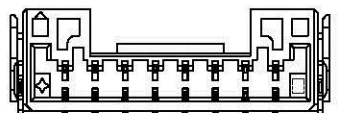

09P

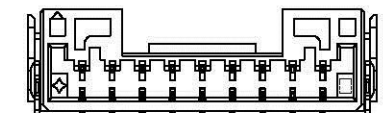

10P

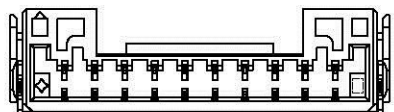

11P

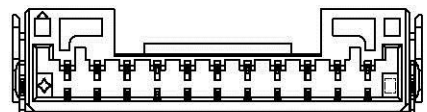

12P

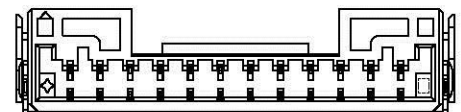

13P

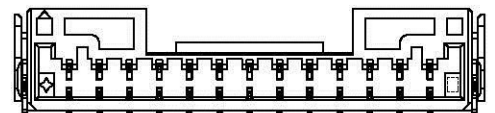

14P

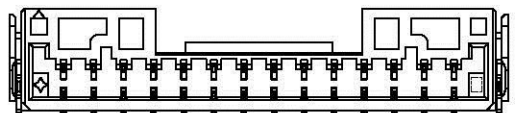

15P

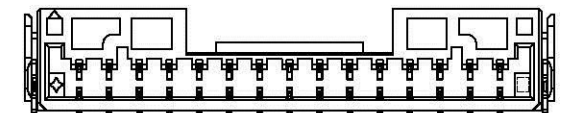

<p>TOLERANCE</p> <p>X.X ±0.25</p> <p>X.XX ±0.15</p> <p>ANGULA 3°</p> <p>UNLESS OTHERWISE SPECIFIED</p>	APPROVALS		DATE		
	DRAWN <i>Siuon Kong</i>		04/28/14	<p>www.allconnectors.de</p> <p>Tel.: 0049 711 7000503</p> <p>70724 Illerstedt - Germany</p>	
	CHK'D <i>Paul Chen</i>		04/28/14	<p>Info: @allconnectors.de</p> <p>Fax: 0049 711 7000504</p> <p>Kettnerstr. 25</p>	
	APP'D <i>Wayne Lai</i>		04/28/14	<p>PART NO.</p> <p>TU1211WNR-1xNPSK-*-NL-M-A</p>	
	UNITS mm		SCALE 1:1	SIZE: A4	<p>DRAWING NO.</p> <p>EN-TU1211WNR-1xNPSK-*-NL-M-A</p>

TITLE:  
WIRE TO BOARD, WAFER,  
PITCH 1.25mm, RIGHT ANGLE,  
SMT TYPE, ASSEMBLY

REV. A/5

This document is the property of Targ Yu Enterprise and is delivered on the express condition that it is not to be disclosed, reproduced or used, in whole or in part, for manufacture or sale by anyone other than Targ Yu Enterprise without its prior consent, and that no right is granted to disclose or to use any information in this document.

# Engineer Drawing

REV	ECN NO.	DESCRIPTION	DATE	APP'D
A/3	N/A	ADD PACKING SPECIFICATION	10/15/13	Paul
A/4	ECN-EN-2014014	UPDATE DRAWING	03/11/14	Paul
A/5	ECN-EN-2014029	AMEND PACKING	04/28/14	Paul

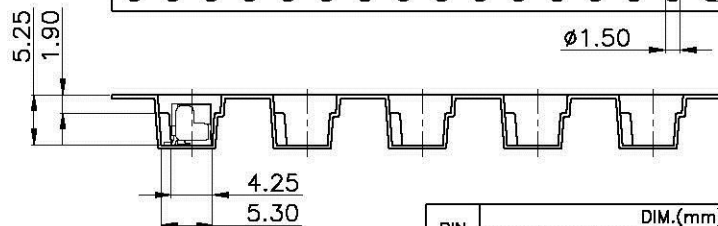
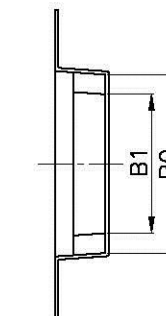
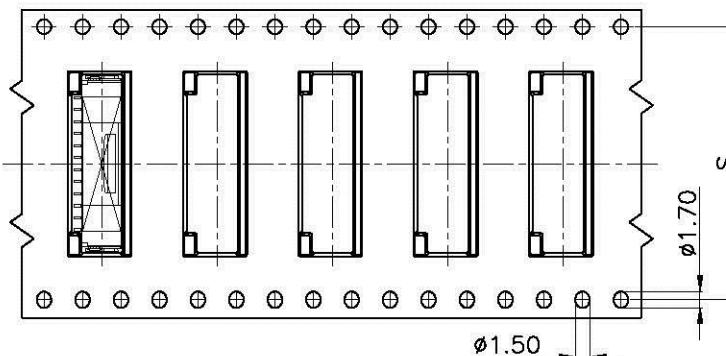
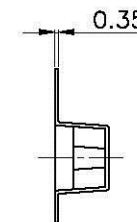
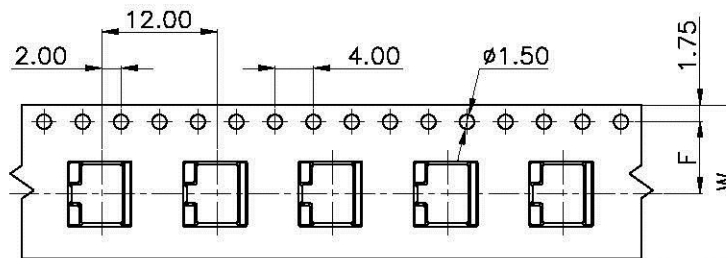
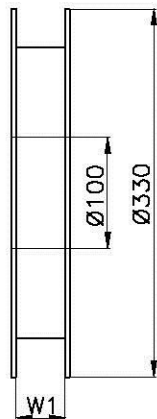
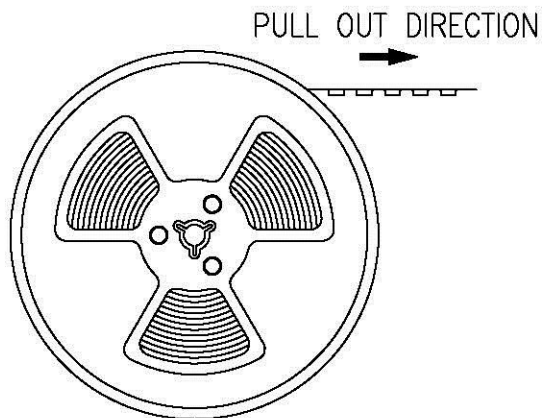

PIN	DIM.(mm)							PIN	DIM.(mm)							
	B0	B1	B2	F	S	W	W1		B0	B1	B2	F	S	W	W1	
2	6.05	4.40	4.40	7.50	/	16.00	16.50	09	16.80	11.90	4.40	11.50	/	24.00	24.50	
3	7.30	4.40	4.40	7.50		16.00	16.50	10	18.30	13.15	4.40	11.50		24.00	24.50	
4	8.55	5.65	4.40	7.50		16.00	16.50	11	19.80	14.40	4.40	14.20		28.40	32.00	32.50
5	9.80	6.90	4.40	11.50		24.00	24.50	12	21.30	15.65	4.40	14.20		28.40	32.00	32.50
6	11.05	8.15	4.40	11.50		24.00	24.50	13	22.80	16.90	4.40	14.20		28.40	32.00	32.50
7	12.30	9.40	4.40	11.50		24.00	24.50	14	24.30	18.15	4.40	14.20		28.40	32.00	32.50
8	13.55	10.65	4.40	11.50		24.00	24.50	15	25.80	19.40	4.40	20.20		40.40	44.00	44.50

- NOTES:
- 10 SPROCKET HOLE PITCH CUMULATIVE TOLERANCE  $\pm 0.20$
  - CARRIER CAMBER IS WITHIN 1 mm IN 250 mm
  - MATERIAL : BLACK CONDUCTIVE POLYSTYRENE ALLOY.(UP-5000)
  - ALL DIMENSIONS MEET EIA-481-C REQUIREMENTS
  - THICKNESS :  $0.35 \pm 0.05$ mm
  - COMPONENT LOAD PER 13" REEL : 1000 PCS

TOLERANCE	APPROVALS	DATE	All Connectors	
X.X $\pm 0.25$	DRAWN <i>Iwen Kong</i>	04/28/14'	www.allconnectors.de Tel.: 0049 711 7009503 70734 Filderstadt - Germany	info@allconnectors.de Fax: 0049 711 7009504 Kettnerstr. 25
X.XX $\pm 0.15$	CHK'D <i>Paul Chen</i>	04/28/14'	PART NO. TU1211WNR-1xNPSK-*-NL-M-A	TITLE: WIRE TO BOARD, WAFER, PITCH 1.25mm, RIGHT ANGLE, SMT TYPE, ASSEMBLY
ANGULA 3'	APP'D <i>Wayne Lai</i>	04/28/14'	DRAWING NO. EN-TU1211WNR-1xNPSK-*-NL-M-A	
UNLESS OTHERWISE SPECIFIED	UNITS mm	SCALE 1:1	SIZE: A4	SHEET 3 OF 4

REV. A/5

This document is the property of Targ Yu Enterprise and is delivered on the express condition that it is not to be disclosed, reproduced or used, in whole or in part, for manufacture or sale by anyone other than Targ Yu Enterprise without its prior consent, and that no right is granted to disclose or to use any information in this document.

# Engineer Drawing

REV	ECN NO.	DESCRIPTION	DATE	APP'D
A/3	N/A	ADD PACKING SPECIFICATION	10/15/13	Paul
A/4	ECN-EN-2014014	UPDATE DRAWING	03/11/14	Paul
A/5	ECN-EN-2014029	AMEND PACKING	04/28/14	Paul

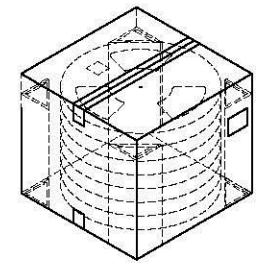
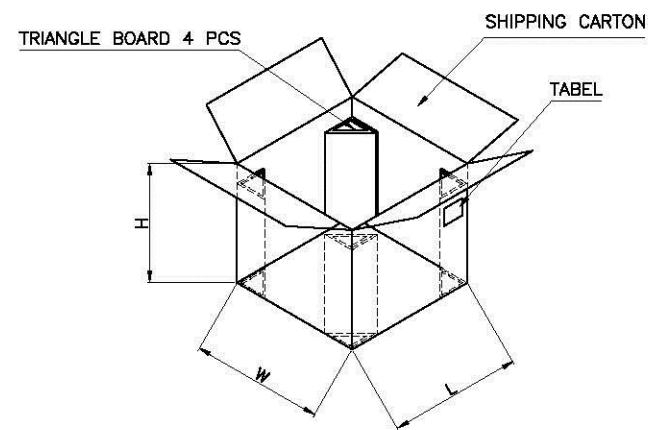
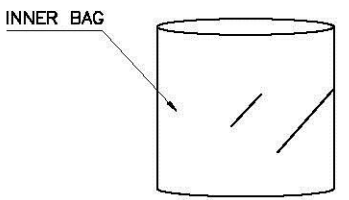
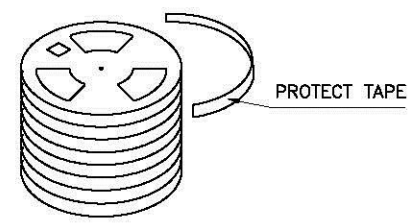
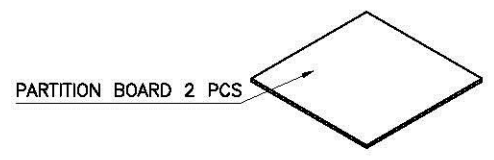

PACKING MATERIAL	
PART NAME	DIM.(mm)
REEL	φ330*(W+0.5)
CARTON	350*350*340

PACKING CAPACITY			
PIN	PCS/RE	RE/BC	PCS/BC
02~04	1000 PCS/RE	14 RE/BC	14,000 PCS/BC
05~10	1000 PCS/RE	10 RE/BC	10,000 PCS/BC
11~14	1000 PCS/RE	8 RE/BC	8,000 PCS/BC
15	1000 PCS/RE	6 RE/BC	6,000 PCS/BC

TOLERANCE		APPROVALS		DATE	All Connectors		
X.X	±0.25	DRAWN	<i>Iwen Kong</i>	04/28/14	www.allconnectors.de Tel.: 0049 711 7009503 70794 Filderstadt Germany	info@allconnectors.de Fax: 0049 711 7009504 Kettnerstr. 25	
X.XX	±0.15	CHK'D	<i>Paul Chen</i>	04/28/14	PART NO.	TITLE: WIRE TO BOARD, WAFER, PITCH 1.25mm, RIGHT ANGLE, SMT TYPE, ASSEMBLY	
ANGULA	3'	APP'D	<i>Wayne Lai</i>	04/28/14	TU1211WNR-1xNPSK-*-NL-M-A DRAWING NO. EN-TU1211WNR-1xNPSK-*-NL-M-A		
UNLESS OTHERWISE SPECIFIED		UNITS mm	SCALE 1:1	SIZE: A4	⊗	SHEET 4 OF 4	REV. A/5