

This document is the property of Targ Yu Enterprise and is delivered on the express condition that it is not to be disclosed, reproduced or used, in whole or in part, for manufacture or sale by anyone other than Targ Yu Enterprise without its prior consent, and that no right is granted to disclose or to use any information in this document.

# Engineer Drawing

REV	ECN NO.	DESCRIPTION	DATE	APP'D
A/0		RELEASE TO PRODUCTION	11/20/09	Goldberg

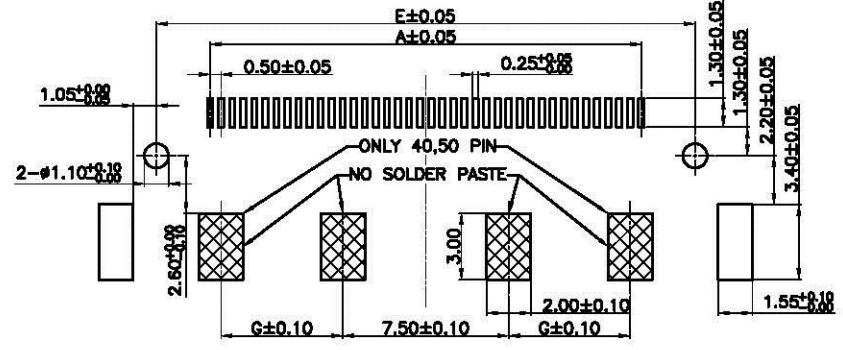
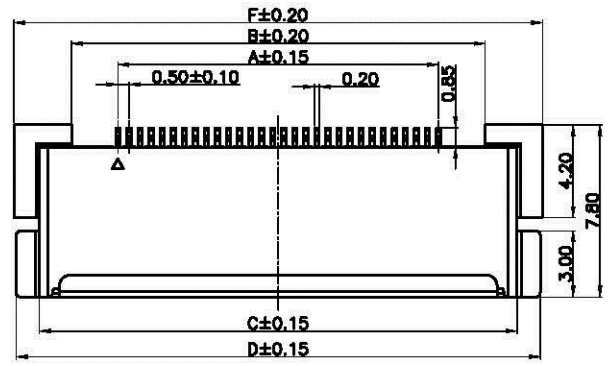

P.C.B. Layout

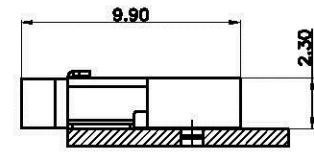
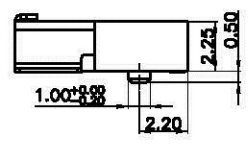
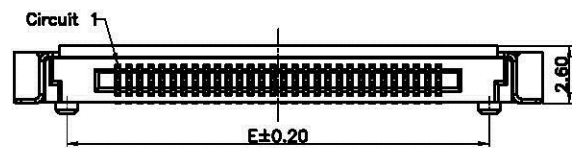

Mating Condition (REF.)

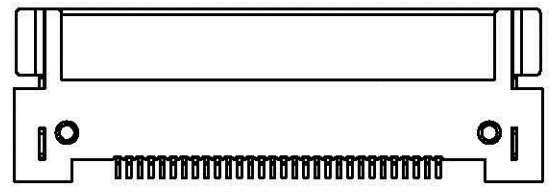

Pin	DIM:(mm)						
	A	B	C	D	E	F	G
20	9.50	13.70	16.60	18.70	14.10	18.90	-
30	14.50	18.70	21.60	23.70	19.10	23.90	-
40	19.50	23.70	26.60	28.70	24.10	28.90	5.50
50	24.50	28.70	31.60	33.70	29.10	33.90	5.50

NOTES:

- MATERIAL  
INSULATOR: LCP, UL94V-0 (CREAM)  
CONTACT: PHOSPHOR BRONZE  
REAR SHELL: BRASS/GOLD FLASH ON SOLDER AREA
  - CONTACT FINISH : G0 GOLD FLASH OVER NICKEL  
G3 3u" GOLD FLASH OVER NICKEL.
  - ORDERING CODE: TS0506WNR-NPS-x-NL
- PIN NO. \_\_\_\_\_ NL HALOGEN FREE  
 S SMT TYPE \_\_\_\_\_ CONTACT FINISH SEE NOTE 2

<b>TOLERANCE</b>  X. ±0.30 X.X ±0.25 X.XX ±0.15 X.XXX ±0.08 ANGULA 3°  UNLESS OTHERWISE SPECIFIED	<b>APPROVALS</b> DRAWN Vinson Hu		<b>DATE</b> 11/20/09	 www.allconnectors.de Tel.: 0049 711 7000503 70791 Filderstadt - Germany		
	CHK'D Goldberg Chen		11/20/09			
	APP'D Wayne Lai		11/20/09	<b>PART NO.</b> TS0506WNR-NPS-x-NL	<b>TITLE:</b> WIRE TO BOARD, RECEPTACLE, PITCH 0.50mm, SMT TYPE, ASSEMBLY	
	UNITS mm	SCALE 1:1	SIZE: A4		SHEET 1 OF 3	REV. A/0

This document is the property of Targ Yu Enterprise and is delivered on the express condition that it is not to be disclosed, reproduced or used, in whole or in part, for manufacture or sale by anyone other than Targ Yu Enterprise without its prior consent, and that no right is granted to disclose or to use any information in this document.

# Engineer Drawing

REV	ECN NO.	DESCRIPTION	DATE	APP'D
A/0		RELEASE TO PRODUCTION	11/20/09	Goldberg

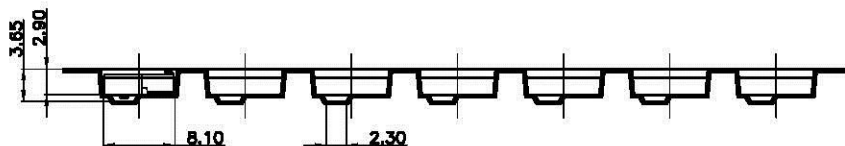
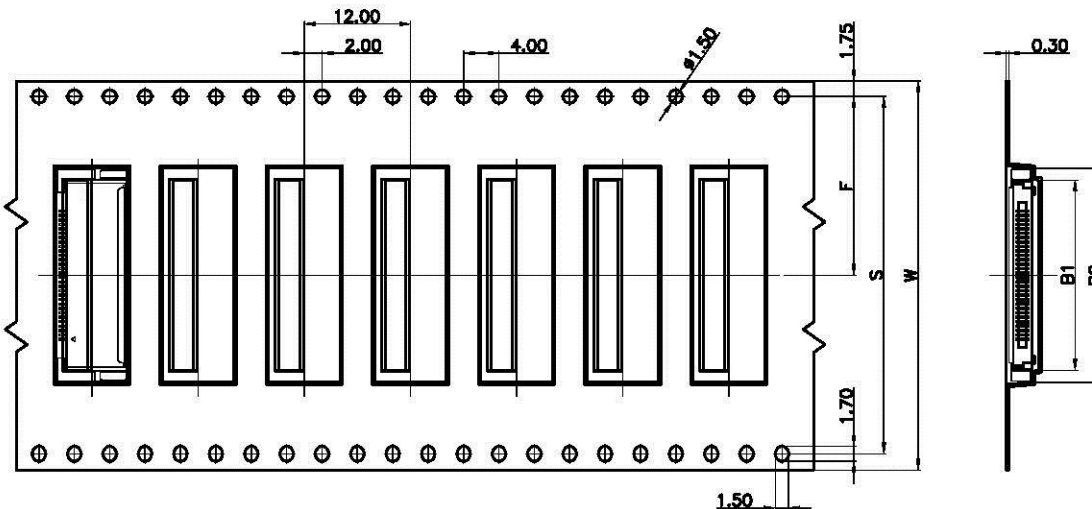
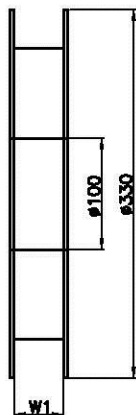
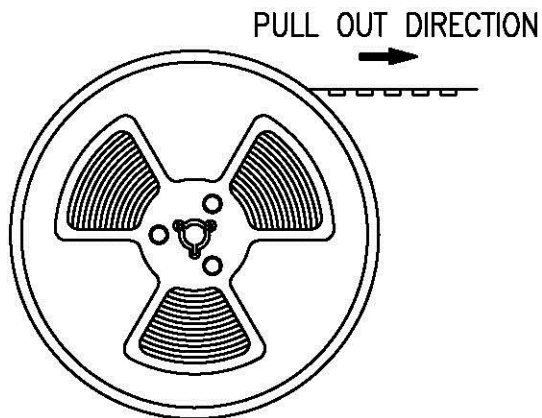

Pin	DIM:(mm)					
	B0	B1	F	S	W	W1
20	19.20	16.50	14.20	28.40	32.00	33.50
30	24.20	21.50	20.20	40.40	44.00	45.50
40	29.20	26.50	20.20	40.40	44.00	45.50
50	34.20	31.50	20.20	40.40	44.00	45.50

## NOTES:

- 10 SPROCKET HOLE PITCH CUMULATIVE TOLERANCE  $\pm 0.20$ .
- CARRIER CAMBER IS WITHIN 1 mm IN 250 mm.
- MATERIAL : BLACK CONDUCTIVE POLYSTYRENE ALLOY.(UP-5000)
- ALL DIMENSIONS MEET EIA-481-C REQUIREMENTS.
- THICKNESS :  $0.30 \pm 0.05$ mm.
- COMPONENT LOAD PER 13" REEL : 1500 PCS.

TOLERANCE		APPROVALS		DATE	All Connectors	
X.	$\pm 0.30$	DRAWN Vinson Hu		11/20/09'	www.allconnectors.com Tel.: 0049 711 7009503 70591 Hilderstadt - Germany	
X.X	$\pm 0.25$	CHK'D Goldberg Chen		11/20/09'	PART NO. TS0506WNR-NPS-x-NL	TITLE: WIRE TO BOARD, RECEPTACLE, PITCH 0.50mm, SMT TYPE, ASSEMBLY
X.XX	$\pm 0.15$	APP'D Wayne Lai		11/20/09'	DRAWING NO. EN-TS0506WNR-NPS-x-NL	
X.XXX	$\pm 0.08$	UNITS mm		SCALE 1:1	SIZE: A4	SHEET 2 OF 3
ANGULA	3'	UNLESS OTHERWISE SPECIFIED				

REV. A/0

This document is the property of Targ Yu Enterprise and is delivered on the express condition that it is not to be disclosed, reproduced or used, in whole or in part, for manufacture or sale by anyone other than Targ Yu Enterprise without its prior consent, and that no right is granted to disclose or to use any information in this document.

# Engineer Drawing

REV	ECN NO.	DESCRIPTION	DATE	APP'D
A/0		RELEASE TO PRODUCTION	11/20/09	Goldberg

PARTITION BOARD 2 PCS

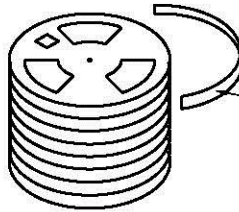
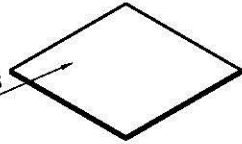

PROTECT TAPE



INNER BAG

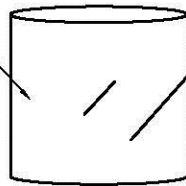

TRIANGLE BOARD 4 PCS

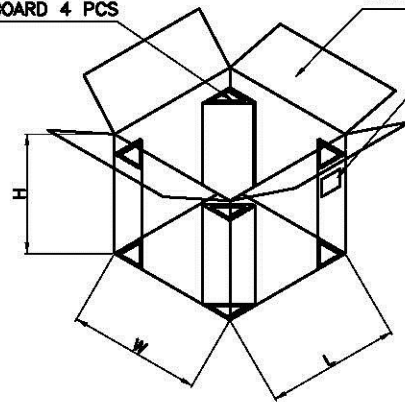

SHIPPING CARTON

TABEL

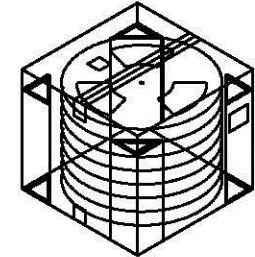

### PACKING MATERIAL

PART NAME	DIM(mm)
REEL	ø300*(W+0.5)
CARTON	350*350*340

### PACKING CAPACITY

PART NO.	PCS/RE	RE/BC	PCS/BC
TS0506WNR-20S-x-NL	1,500PCS/RE	8 RE/BC	12,000 PCS/BC
TS0506WNR-30S-x-NL	1,500PCS/RE	6 RE/BC	9,000 PCS/BC
TS0506WNR-40S-x-NL	1,500PCS/RE	6 RE/BC	9,000 PCS/BC
TS0506WNR-50S-x-NL	1,500PCS/RE	6 RE/BC	9,000 PCS/BC

TOLERANCE	
X.	±0.30
X.X	±0.25
X.XX	±0.15
X.XXX	±0.08
ANGULA	3'
UNLESS OTHERWISE SPECIFIED	

APPROVALS	DATE
DRAWN Vinson Hu	11/20/09'
CHK'D Goldberg Chen	11/20/09'
APP'D Wayne Lai	11/20/09'
UNITS mm	SCALE 1:1

DATE
11/20/09'
11/20/09'
11/20/09'
SIZE: A4

**All Connectors**  
 www.allconnectors.de  
 TEL: 0049 211 7009500  
 20724 EILDEKSTADT - Germany

info@allconnectors.de  
 FAX: 0049 211 7009504  
 Kette 16er Str. 25

PART NO. TS0506WNR-NPS-x-NL	TITLE: WIRE TO BOARD, RECEPTACLE, PITCH 0.50mm, SMT TYPE, ASSEMBLY
DRAWING NO. EN-TS0506WNR-NPS-x-NL	

SHEET 3 OF 3

REV. A/0