

This document is the property of Targ Yu Enterprise and is delivered on the express condition that it is not to be disclosed, reproduced or used, in whole or in part, for manufacture or sale by anyone other than Targ Yu Enterprise without its prior consent, and that no right is granted to disclose or to use any information in this document.

Engineer Drawing

REV	ECN NO.	DESCRIPTION	DATE	APP'D
A/0	N/A	NEW DRAWING	03/06/13	Paul
A/1	ECN-EN-2013085	AMEND PRODUCTION	11/18/13	Paul

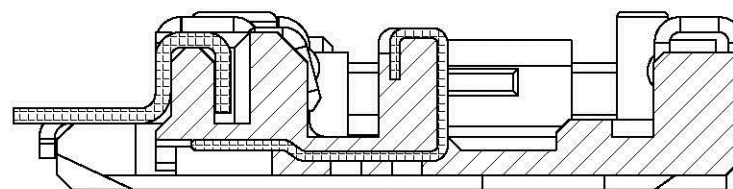
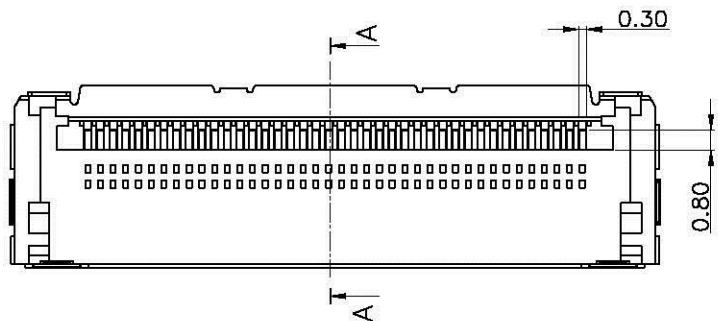
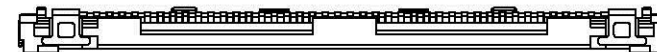
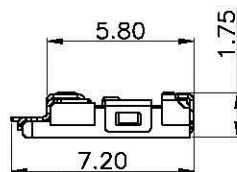
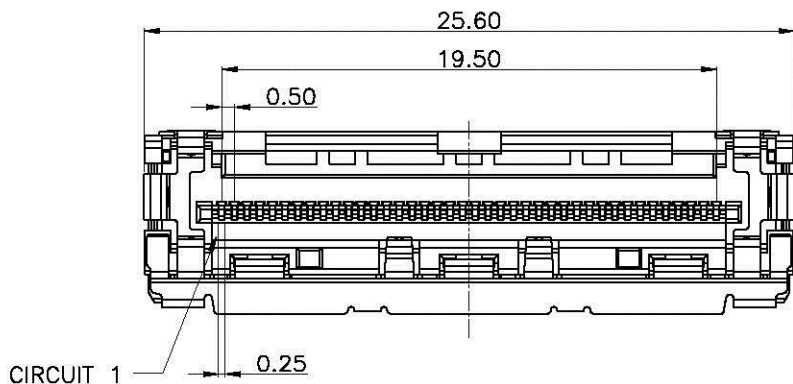

DETAIL A: (SCALE 4:1)

NOTES:

- MATERIAL
INSULATION: LCP, UL94V-0 (BLACK)
CONTACT: COPPER ALLOY
SHELL: COPPER ALLOY / TIN-PLATED OVER NICKEL
- CONTACT FINISH: G0--GOLD FLASH OVER NICKEL
G*--GOLD *u" OVER NICKEL
- MATES WITH: TD0502 SERIES WAFER
- ORDERING CODE: TD0502HNO-40-*--NL
PIN NO. HALOGEN FREE
FINISH SEE NOTE 2

TOLERANCE		APPROVALS		DATE	All Connectors	
X.X	±0.30	DRAWN	<i>Suen Kong</i>	11/18/13	www.allconnectors.de Tel.: 0049 711 7000500 info@allconnectors.de Fax: 0049 711 7000504 Kottbusstr. 25	
X.XX	±0.20	CHK'D	<i>Paul Chen</i>	11/18/13	PART NO.	TITLE: WIRE TO BOARD, PLUG, PITCH 0.50mm, INSULATOR INSERTMOLDING
ANGULA	3°	APP'D	<i>Wayne Lai</i>	11/18/13	TD0502HNO-40-*--NL	
UNLESS OTHERWISE SPECIFIED		UNITS mm	SCALE 1:1	SIZE: A4	DRAWING NO.	REV. A/1
					EN-TD0502HNO-40-*--NL	SHEET 1 OF 3

This document is the property of Targ Yu Enterprise and is delivered on the express condition that it is not to be disclosed, reproduced or used, in whole or in part, for manufacture or sale by anyone other than Targ Yu Enterprise without its prior consent, and that no right is granted to disclose or to use any information in this document.

Engineer Drawing

REV	ECN NO.	DESCRIPTION	DATE	APP'D
A/0	N/A	NEW DRAWING	03/06/13	Paul
A/1	ECN-EN-2013085	AMEND PRODUCTION	11/18/13	Paul

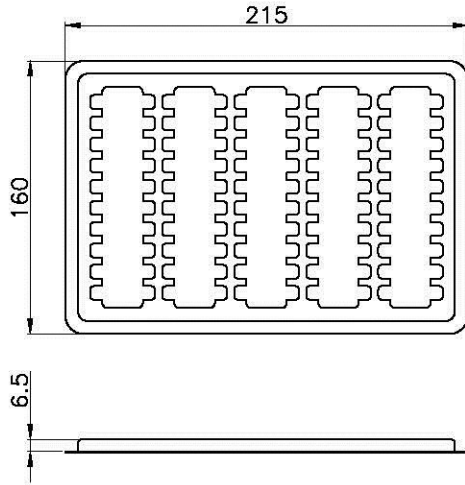

TRAY

PACKING MATERIAL

PART NAME	DIM(mm)	Q'ty
TRAY	215*160*6.5	210
PE BAG	N/A	10
DRIER	N/A	APPROPRIATE
CARTON	350*350*340	1

PACKING CAPACITY

PART NO.	PCS/TR	TR/BC	PCS/BC
TD0502HNO-40-*--NL	50PCS/TR	200 TR/BC	10,000 PCS/BC

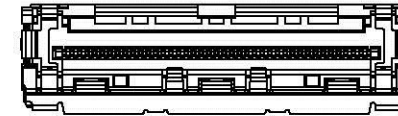

PRODUCT

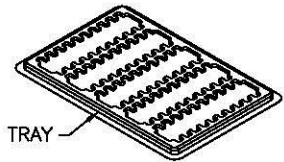

TRAY

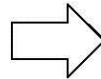

PE BAG
20 TR/PE BAG

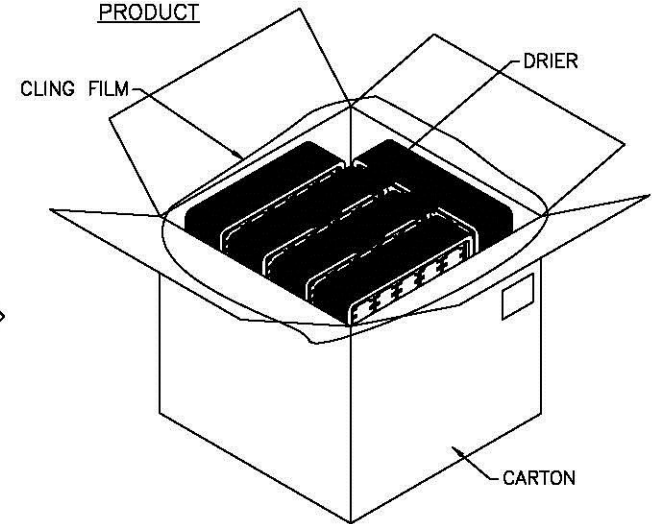
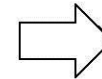
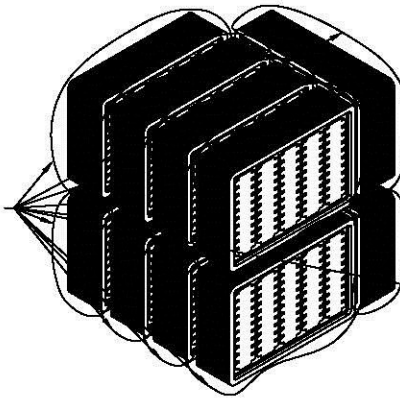

- NOTES:
1. SHOWN; ACCORDING TO THE QUANTITY SPECIFIED IN THE PRODUCT INTO THE TRAY.
 2. ADD APPROPRIATE AMOUNT OF DESICCANT, THE USE OF CLING FILM PACKAGING, AND THEN PE BAG, AND FINALLY INTO THE CARTONS, SEALING TAPE.

TOLERANCE	APPROVALS	DATE	All Connectors	
X.X ±0.30	DRAWN <i>Suen Kong</i>	11/18/13'	www.allconnectors.de Tel.: 0049 711 7000500 20794 Filderstadt - Germany	info@allconnectors.de Fax: 0049 711 7000504 Kullmeyerstr. 25
X.XX ±0.20	CHK'D <i>Paul Chen</i>	11/18/13'	PART NO. TD0502HNO-40-*--NL	TITLE: WIRE TO BOARD, PLUG, PITCH 0.50mm, INSULATOR INSERTMOLDING
ANGULA 3'	APP'D <i>Wayne Lai</i>	11/18/13'	DRAWING NO. EN-TD0502HNO-40-*--NL	
UNLESS OTHERWISE SPECIFIED	UNITS mm	SCALE 1:1	SIZE: A4	SHEET 2 OF 3

REV. A/1

This document is the property of Targ Yu Enterprise and is delivered on the express condition that it is not to be disclosed, reproduced or used, in whole or in part, for manufacture or sale by anyone other than Targ Yu Enterprise without its prior consent, and that no right is granted to disclose or to use any information in this document.

Engineer Drawing

REV	ECN NO.	DESCRIPTION	DATE	APP'D
A/0	N/A	NEW DRAWING	03/06/13	Paul
A/1	ECN-EN-2013085	AMEND PRODUCTION	11/18/13	Paul

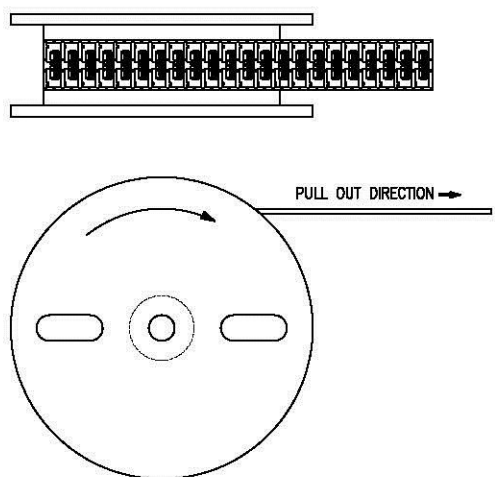
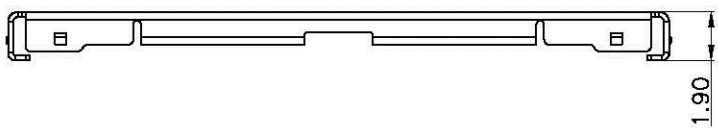
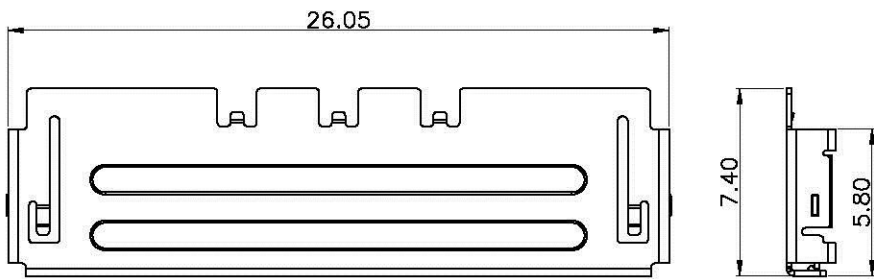

PACKING MATERIAL

PART NAME	DIM(mm)
CARTON	470*470*210

PACKING CAPACITY

PART NO.	PCS/RE	RE/BC	PCS/BC
TD0502EMISOF-40-NE	5,000PCS/RE	3 RE/BC	15,000 PCS/BC

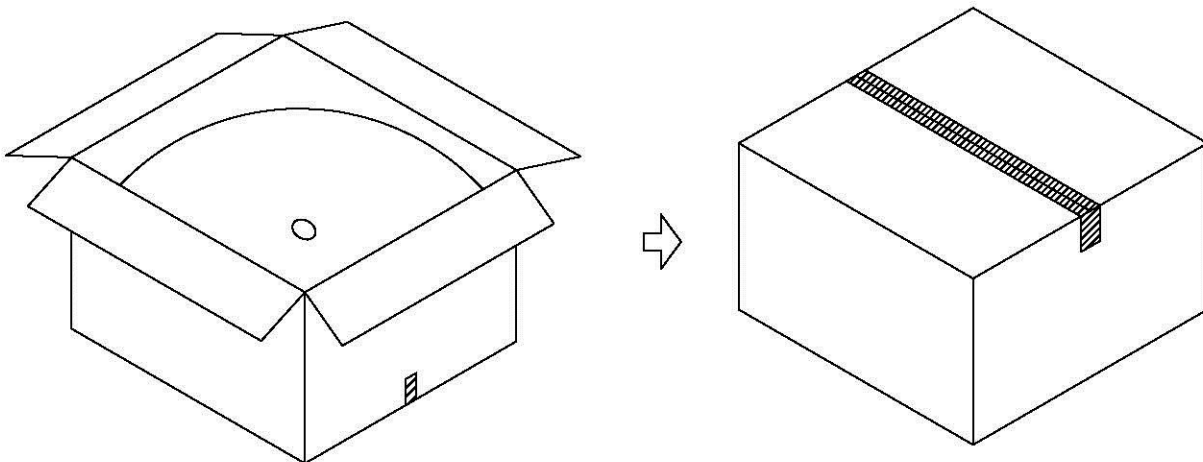

- NOTES:
- MATERIAL: STAINLESS STEEL T=0.20mm
 - PACKING: 5K/REEL
 - ORDERING CODE: TD0502EMISOF-40-NE

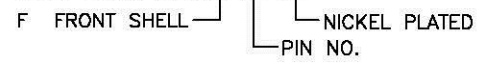

TOLERANCE	APPROVALS	DATE	All Connectors	
X.X ±0.30	DRAWN <i>Suen Kong</i>	11/18/13	www.allconnectors.de Tel.: 0049 711 7009500 20744 Hildersdorf Germany	info@allconnectors.de Fax: 0049 711 7009504 Kettnerstr. 25
X.XX ±0.20	CHK'D <i>Paul Chen</i>	11/18/13	PART NO. TD0502HNO-40-* -NL	TITLE: WIRE TO BOARD, PLUG, PITCH 0.50mm, INSULATOR INSERTMOLDING
ANGULA 3°	APP'D <i>Wayne Lai</i>	11/18/13	DRAWING NO. EN-TD0502HNO-40-* -NL	
UNLESS OTHERWISE SPECIFIED	UNITS mm	SCALE 1:1	SIZE: A4	REV. A/1