

NOTES :
 1. Material :
 Housing : High temperature thermoplastic, UL94-V0.
 Color : White
 Terminal : Copper Alloy.
 Shield : Copper Alloy.
 2. Shield:
 50 U* MIN. NICKEL PLATING OVER ALL.

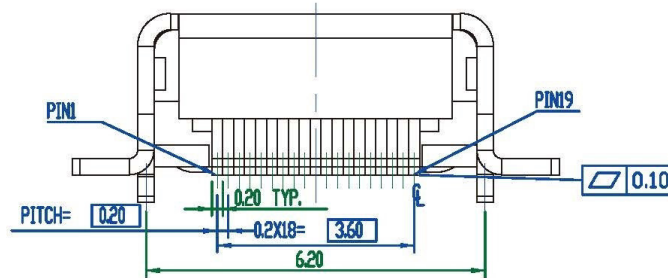
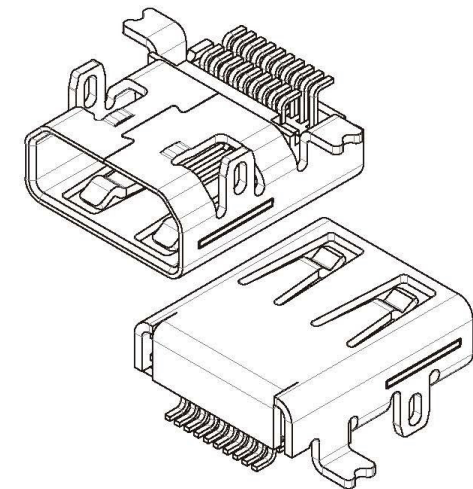
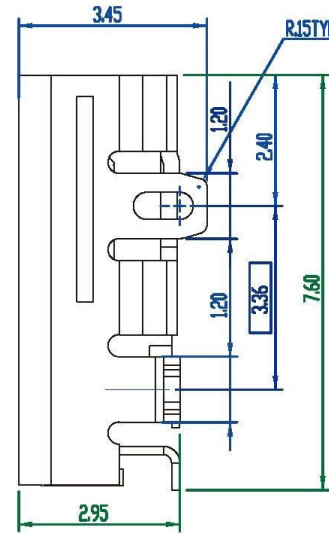
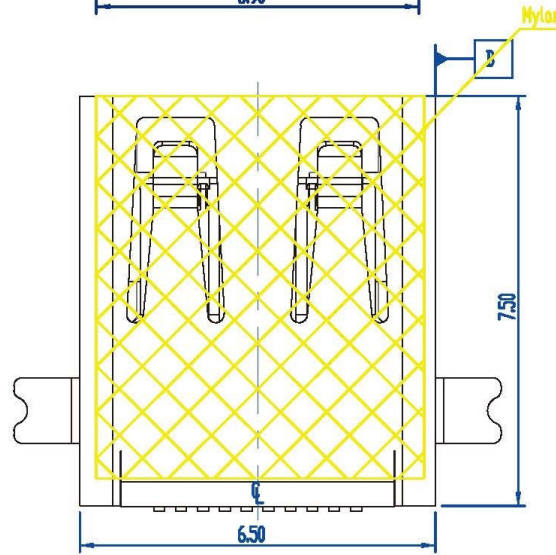
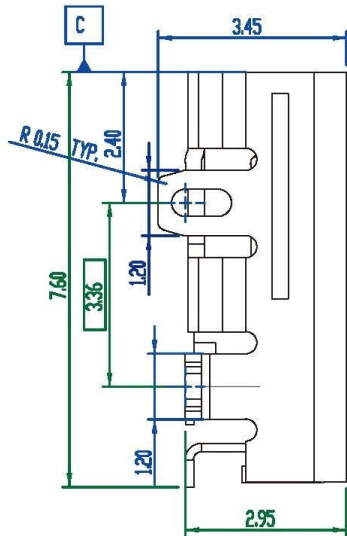

All Connectors

www.allconnectors.de
 Tel.: 0049 711 7003503
 70734 Filderstadt - Germany

Info@allconnectors.de
 Fax: 0049 711 7009501
 Kettnerstr. 25

RoHS Compliant

DRAWING BY CY
 CHECKED BY GENIUS
 UNIT/ mm SCALE 1:1
 DATE
 SIZE A4

TOLERANCES ARE

X ± 0.40
 X ± 0.30
 .XX ± 0.20
 .XXX ± 0.10
 ANG ±

PROJECTION

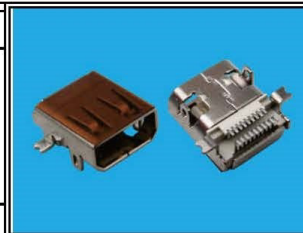

ORDER INFORMATION

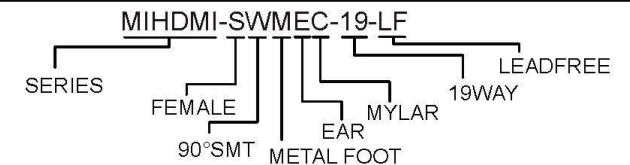

DESCRIPTION:

