

NOTES:
 1. Material:
 Housing: High temperature thermoplastic, UL94-V0.
 Color: Black
 HDMI Terminal: Copper Alloy.
 Cover: Copper Alloy.
 2. Finish:
 Terminal: Underplate: Ni 50 μ" MIN. over all.
 Sn & 100 MIN Solder tail μ" Sn100 MIN Lead free over Ni plate.
 Contact area: Au over Ni plate
 Cover: Underplate: 50 μ" MIN. Ni over all.
 over Ni.
 3. Coplanarity Must Be Within 0.12 Max.

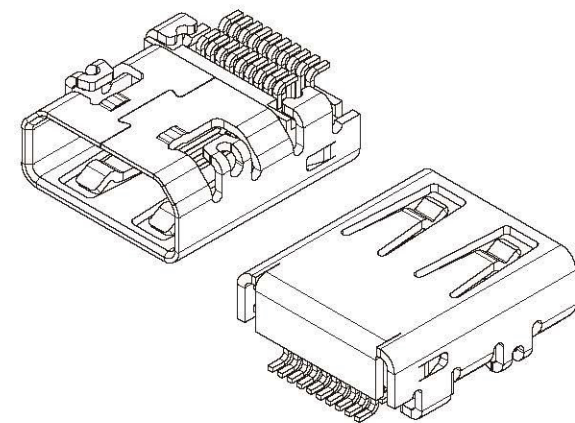

MIHDMI-SWJJR-19-LF
 LEADFREE
 RoHS Compliant

All connectors

www.allconnectors.de
 Tel.: 0049 711 7009503
 70794 Filderstadt - Germany

info@allconnectors.de
 Fax: 0049 711 7009504
 Kettnerstr. 25

PART NO. MIHDMI-SWJJR-19		CHECKED BY CY	TOLERANCES ARE X ± .XX ± .XXX ± AWG	DESCRIPTION:			
DWG NO. MIHDMI-SWJJR-19							
FILE NO.		PROJECTION	AREA	REVISIONS	HK	DATE	
UNIT / mm	SCALE 1:1						

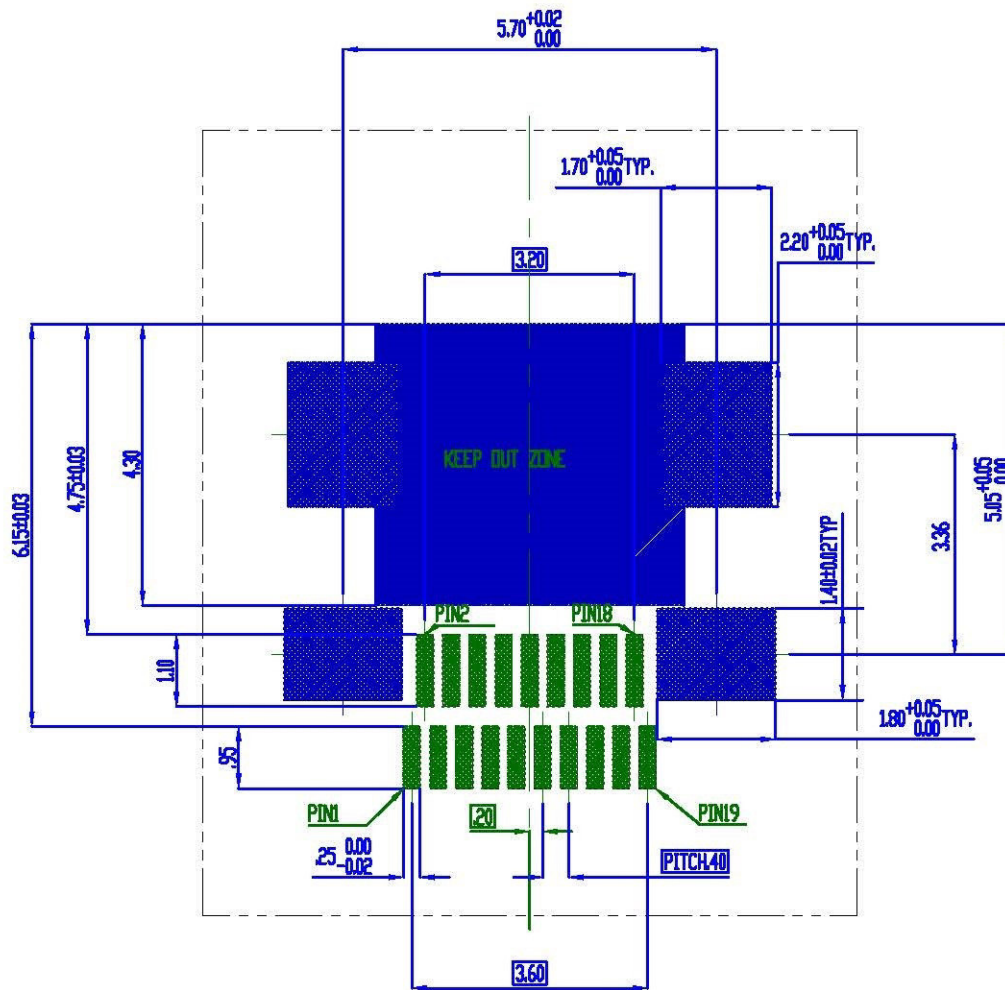

Recommend PCB Layout Tolerance = +/- 0.02 mm

HDMI Each Signal Terminal
Will Be Functional After Detected.

19	5V Power
18	SDA
17	SCL
16	DDC/CEC Ground
15	CEC
14	TMDS Clock-
13	TMDS Clock Shield
12	TMDS Clock+
11	TMDS Data0-
10	TMDS Data0 Shield
09	TMDS Data0+
08	TMDS Data1-
07	TMDS Data1 Shield
06	TMDS Data1+
05	TMDS Data2-
04	TMDS Data2 Shield
03	TMDS Data2+
02	Utility
01	Hot Plug Detect
Pin NO.	Description
Pin Assignment	

Allconnectors

PART NO. MIHDMI-SWJJR-19

DWG NO. MIHDMI-SWJJR-19

FILE NO.

UNIT / mm

SCALE 1:1

CHECKED BY CY

DRAWING BY

PROJECTION



TOLERANCES ARE

X ± 0.3

.XX ± 0.2

.XXX ± 0.1

ANG

DESCRIPTION:

AREA

REVISIONS

HK

DATE

www.allconnectors.de
Tel.: 0049 711 7005903
20754 Filderstadt - Germany

info@allconnectors.de
Fax: 0049 711 7005904
Kette meckr. 25

1. Tape Packed Status

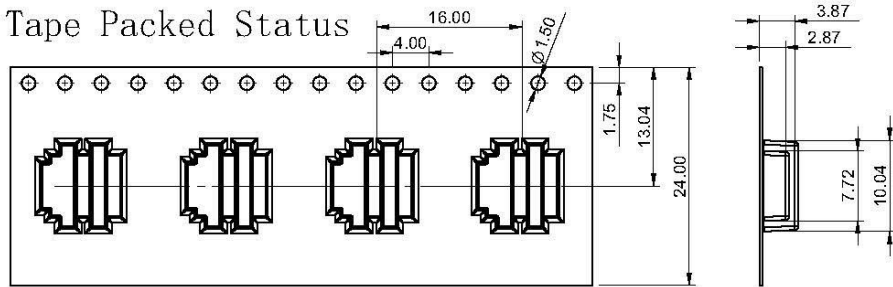

3. Carton Containing 8 Reel (See Chart A)

	Packing Quality	
	Reel	Carton
A	1000	8000

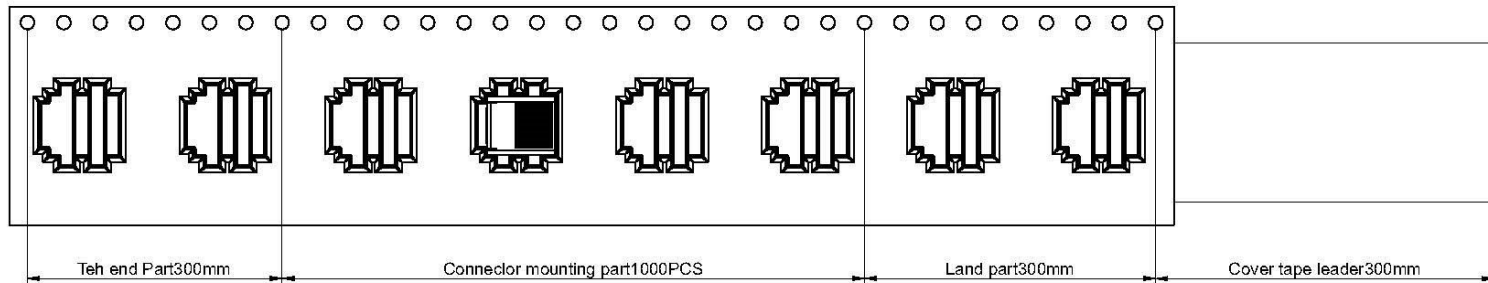
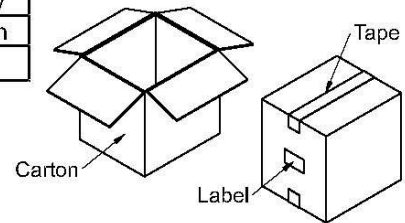

2. Reel Packed Status

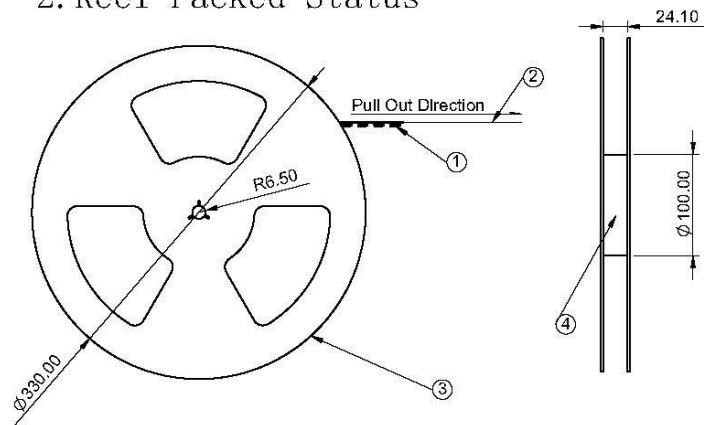

ITEM	NAME	MATERIAL	COLOR
1	CARRIER TAPE	PS	BLACK
2	COVER	PE	TRANSLUCENT
3	REEL PLATE	PS	BLUE
4	REEL CORE	PS	BLUE

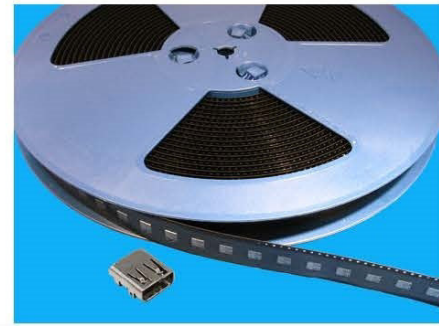

All Connectors

www.allconnectors.de
 TEL: 0049 711 2005003
 40754 Hildenstadt - Germany

info@allconnectors.de
 Fax: 0049 711 2005004
 kactam@tnt.az

PART NO. MIHDMI-SWJJR-19

DWG NO. MIHDMI-SWJJR-19

FILE NO.

UNIT / mm SCALE 1:1

CHECKED BY CY

DRAWING BY

PROJECTION

TOLERANCES ARE

X ±
 .XX ±
 .XXX ±
 AWG

DESCRIPTION:

AREA REVISIONS HK DATE