

NOTE

1. MATERIALS: HOUSING: NYLON 46 (DSM TS250F8) UL94V-0
 COVER: PA9T UL94V-0
 CONTACT: PHOSPHOR BRONZE
 LATCH: BRASS

2.DIMENSION:

PIN	A	B	C	D
3	8.10	1.0	6.10	5.96
4	8.60	1.5	6.60	5.96
5	9.10	2.0	7.10	5.96
6	9.60	2.5	7.60	5.96
7	10.10	3.0	8.10	5.96
8	10.60	3.5	8.60	5.96
9	11.10	4.0	9.10	5.96
10	11.60	4.5	9.60	5.96
11	12.10	5.0	10.10	5.96
12	12.60	5.5	10.60	5.96
13	13.10	6.0	11.10	5.96
14	13.60	6.5	11.60	5.96
15	14.10	7.0	12.10	5.96
16	14.60	7.5	12.60	5.96
17	15.10	8.0	13.10	5.96
18	15.60	8.5	13.60	5.96
19	16.10	9.0	14.10	5.96
20	16.60	9.5	14.60	5.96
21	17.10	10.0	15.10	5.96
22	17.60	10.5	15.60	5.96
23	18.10	11.0	16.10	5.96
24	18.60	11.5	16.60	5.96
25	19.10	12.0	17.10	5.96
26	19.60	12.5	17.60	5.96
27	20.10	13.0	18.10	5.96
28	20.60	13.5	18.60	5.96
29	21.10	14.0	19.10	5.96
30	21.60	14.5	19.60	5.96
31	22.10	15.0	20.10	6.36

PIN	A	B	C	D
32	22.60	15.5	20.60	6.36
33	23.10	16.0	21.10	6.36
34	23.60	16.5	21.60	6.36
35	24.10	17.0	22.10	6.36
36	24.60	17.5	22.60	6.36
37	25.10	18.0	23.10	6.36
38	25.60	18.5	23.60	6.36
39	26.10	19.0	24.10	6.36
40	26.60	19.5	24.60	6.36
41	27.10	20.0	25.10	6.36
42	27.60	20.5	25.60	6.36
43	28.10	21.0	26.10	6.36
44	28.60	21.5	26.60	6.36
45	29.10	22.0	27.10	6.36
46	29.60	22.5	27.60	6.36
47	30.10	23.0	28.10	6.36
48	30.60	23.5	28.60	6.36
49	31.10	24.0	29.10	6.36
50	31.60	24.5	29.60	6.36
51	32.10	25.0	30.10	6.36
52	32.60	25.5	30.60	6.36
53	33.10	26.0	31.10	6.36
54	33.60	26.5	31.60	6.36
55	34.10	27.0	32.10	6.36
56	34.60	27.5	32.60	6.36
57	35.10	28.0	33.10	6.36
58	35.60	28.5	33.60	6.36
59	36.10	29.0	34.10	6.36
60	36.60	29.5	34.60	6.36

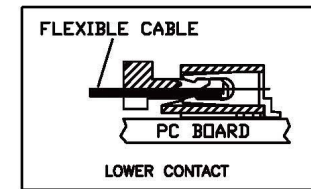
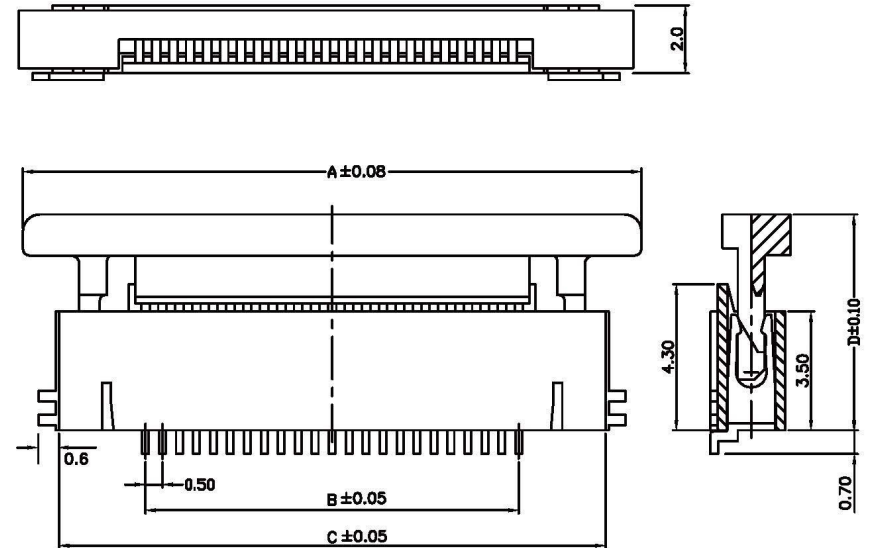
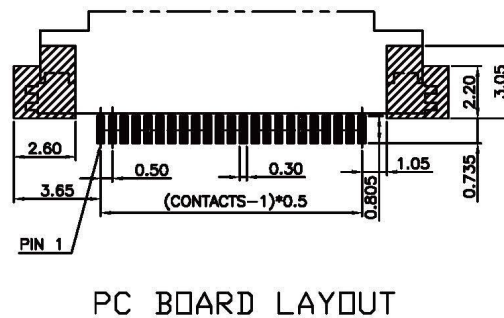
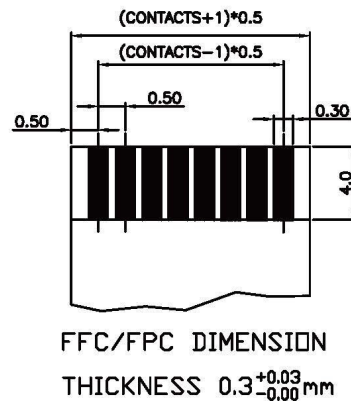

$B=0.5(\text{No. of Contact}-1)$
 $C=B+5.1\text{mm}$

All Connectors

www.allconnectors.de info@allconnectors.de
 Tel.: 0049 711 7009503 Fax: 0049 711 7009504
 70794 Filderstadt - Germany Kettenmerstr. 25

RoHS Compliant

DRAWING BY CY
 CHECKED BY GENIUS
 UNIT/mm SCALE 1:1
 DATE
 SIZE A4 PROJECTION

TOLERANCES ARE

X ±
 X ± 0.20
 XX ± 0.10
 XXX ±
 ANG ±

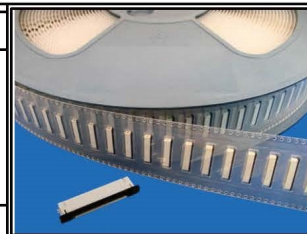

ORDER INFORMATION

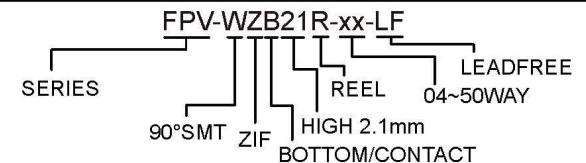

DESCRIPTION: **LOCK 0.5 PITCH 2.0H 抽屜式 下接**

1. 1.10 sprocket hole pitch cumulative tolerance ± 0.20 .
2. Carrier camber is within 1 mm in 100mm.
3. Material: Black Conductive Polystyrene Alloy (UP-5000).
4. All dimensions meet EIA-481-3 requirements.
5. Thickness: 0.3 ± 0.05 mm.
6. Components load per 13" reel: 2000 pcs.

0.5 PH	W
4P~20P	24mm
21P~29P	32mm
30P~50P	44mm
51P~62P	56mm

W尺寸24mm以下

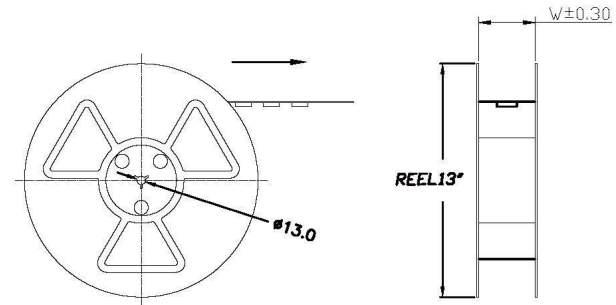
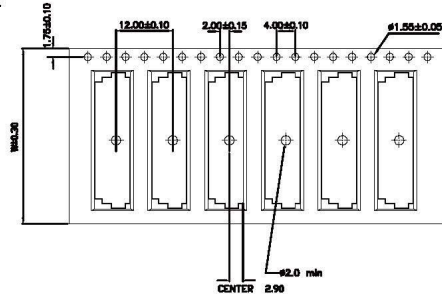

W尺寸32mm以上

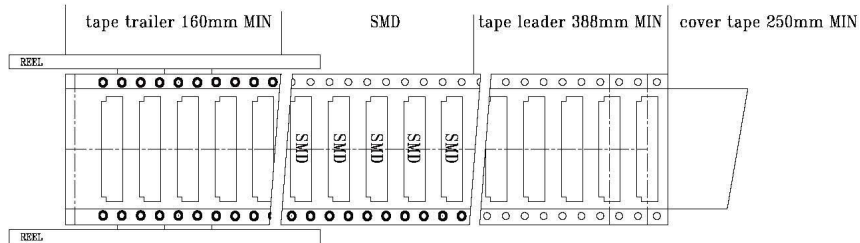
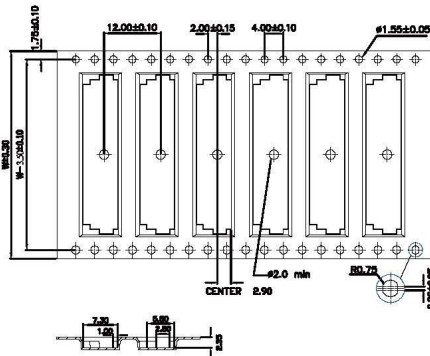

All Connectors

www.allconnectors.de
Tel.: 0049 711 7009503
70794 Filderstadt - Germany

info@allconnectors.de
Fax: 0049 711 7009504
Kettnerstr. 25

RoHS Compliant

DRAWING BY CY
CHECKED BY GENIUS
UNIT/ mm SCALE 1 : 1
DATE
SIZE A4

TOLERANCES ARE

X ±
X ±
.XX ±
XXX ±
ANG ±

PROJECTION

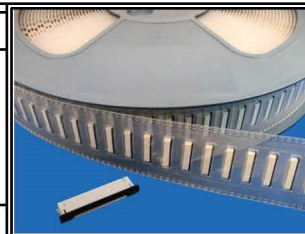

ORDER INFORMATION

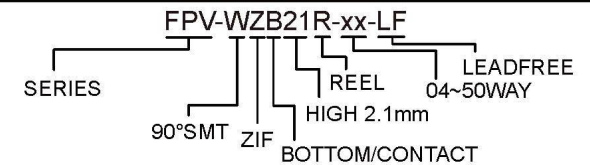

DESCRIPTION: