

NOTE:
 1.MATERIAL:
 HOUSING:THERMOPLASTIC
 CONTACTS:COPPER ALLOY
 2.PLATING:
 CONTACTS:SEE ORDERING INFORMATION
 SOLDER PAD:TIN OVER NICKEL
 3.RATING:
 OPERATING VOLTAGE:50V
 CURRENT RATING:0.4A
 OPERATING TEMPERATURE:-55°C ~ +85°C

No.of Contacts	DIM. A	DIM. B	DIM. C
4	5.53	1.5	2.6
5	6.03	2	3.1
6	6.53	2.5	3.6
7	7.03	3	4.1
8	7.53	3.5	4.6
9	8.03	4	5.1
10	8.53	4.5	5.6
11	9.03	5	6.1
12	9.53	5.5	6.6
13	10.03	6	7.1
14	10.53	6.5	7.6
15	11.03	7	8.1
16	11.53	7.5	8.6
17	12.03	8	9.1
18	12.53	8.5	9.6
19	13.03	9	10.1
20	13.53	9.5	10.6
21	14.03	10	11.1
22	14.53	10.5	11.6
26	15.03	11	12.1
24	15.53	11.5	12.6
25	16.03	12	13.1
26	16.53	12.5	13.6
27	17.03	13	14.1
28	17.53	13.5	14.6
29	18.03	14	15.1
30	18.53	14.5	15.6
31	19.03	15	16.1
32	19.53	15.5	16.6
33	20.03	16	17.1
34	20.53	16.5	17.6
35	21.03	17	18.1
36	21.53	17.5	18.6
37	22.03	18	19.1
38	22.53	18.5	19.6
39	23.03	19	20.1
40	23.53	19.5	20.6
41	24.03	20	21.1
42	24.53	20.5	21.6
43	25.03	21	22.1
44	25.53	21.5	22.6
45	26.03	22	23.1
46	26.53	22.5	23.6
47	27.03	23	24.1
48	27.53	23.5	24.6
49	28.03	24	25.1
50	28.53	24.5	25.6

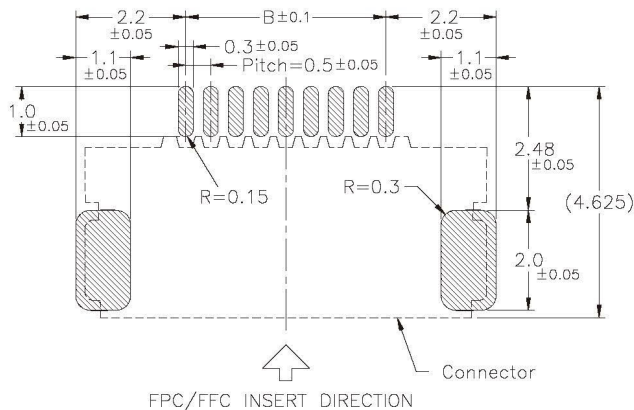

PCB Layout

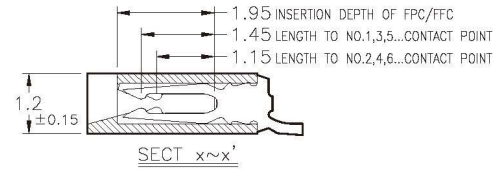
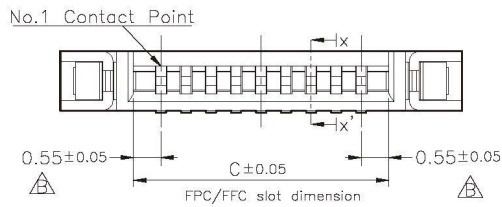
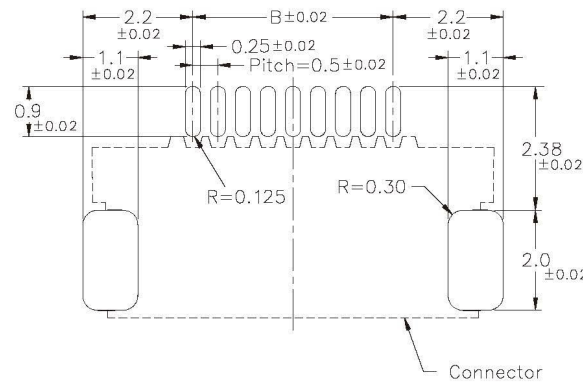

RECOMMENDED METAL MASK PATTERN (THICKNESS 0.1mm)

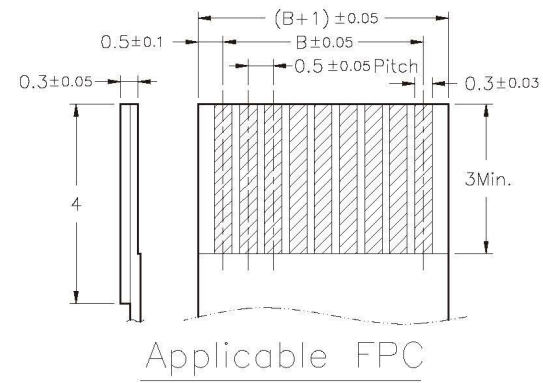

Applicable FPC

本部品不含有環境管理物質規定之有害物質

RoHS Compliant

All Connectors

www.allconnectors.de
 info@allconnectors.de
 Tel.: 0049 711 7009503
 Fax: 0049 711 7009504
 70794 Filderstadt - Germany
 Kettnerstr. 25

DRAWING BY CY		TOLERANCES ARE
CHECKED BY GENIUS		
UNIT / mm	SCALE 1 : 1	.X ±
DATE		.XX ±
		.XXX ±
		ANG ±
SIZE A4	PJECTION	

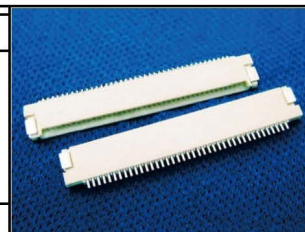

ORDER INFORMATION

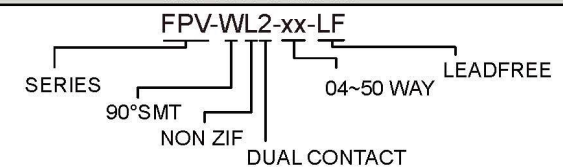

DESCRIPTION: