

SWITCH CIRCUIT

MATERIAL AND FINISH AS BELOW

WHEN CARD IS EJECTED

WHEN CARD IS INSERTED

A	Housing	LCP UL94V-0 Beige	E	
B	Contact	Phosphor Bronze C5210, Contact Area: Gold Flash	F	
C	Latch	Stainless Steel SUS301	G	
D			H	

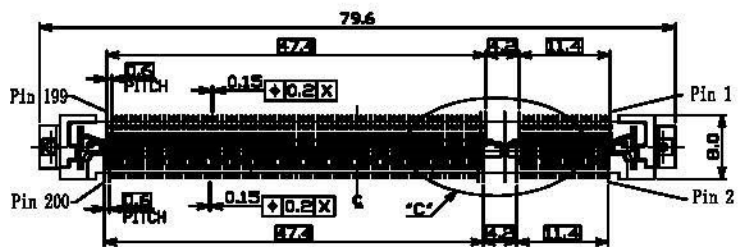

NOTES:
 DATE CODE 2202 (YWW)
 Y: 2 YEAR(2012)
 WW:20 WEEK(01'62)
 D: 2 DAY(01'07)

SPECIFICATION:

- ELECTRICAL**
 - 1.1 Current Rating: 0.5A per pin
 - 1.2 Voltage Rating: 25V AC/DC
 - 1.3 Contact Resistance: 60mΩ
 - 1.4 Insulation Resistance: 500MΩ
 - 1.5 Dielectric Withstanding Voltage: 125VAC

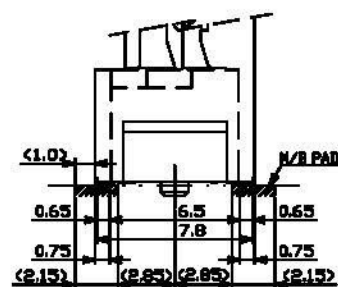
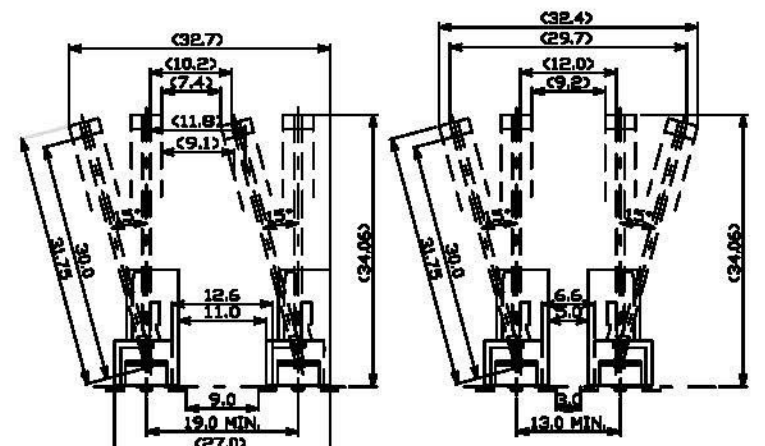
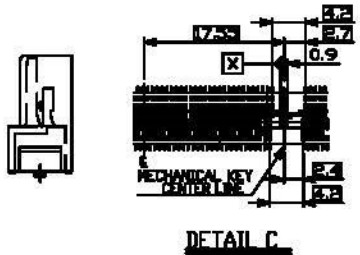
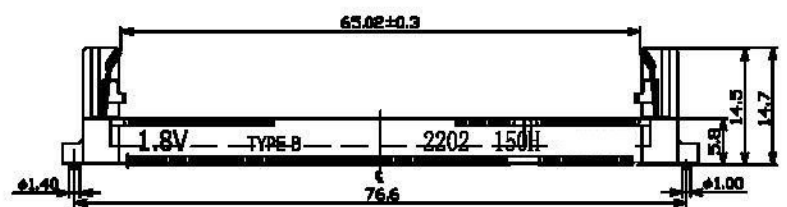

- MECHANICAL**
 - 2.1 Durability: 25 Cycle
 - 2.2 Latch Retention Force: 8 N/Pos. Min

- ENVIRONMENTAL**
 - 3.1 Operating temperature range: -40°C~+85°C
 - 3.2 Storage temperature range: -40°C~+85°C

- SOLDER ABILITY**
 - 4.1 Recommended IR Reflow Temperature: 255°C 10Sec

P1	P2	P3	P4	P5	P6	P7	P8	P9	P10	P11	P12
----	----	----	----	----	----	----	----	----	-----	-----	-----

PIN ASSIGNMENT

121B-150A10	SO DIMM DDR2 Socket 1.8V 200Pin 15.0H Vertical Reverse Type, Contact Area: Gold Flash
-------------	---

PRODUCT NO.	DESCRIPTION	<p>www.allconnectors.com info@allconnectors.com Tel: +86 755 22110000 Fax: +86 755 22110001 (USA) 818-601-9899 (Germany) 49-3608-2012</p>
UNLESS OTHERWISE SPECIFIED TOLERANCE		
ANGLES	ANG. ±0.3 0. ±0.3	
LINEAR	0.0 ±0.25 0.00 ±0.20	
SCALE	AS SHOWN UNIT: mm	
DRAWN	Willis 2012/12/05	DRAWN NAME: SO DIMM DDR2 Socket 1.8V 200Pin 15.0H Vertical Reverse Type PRODUCT NO. 121B-150A10
CHECKED	Angel 2012/12/05	
APPROVED	Ken 2012/12/05	
REV. 1.0	FILE NAME	121B-150A10_B_1

- △ Revise:
- △ Revise:
- △ Revise:

REV.	DESCRIPTION	DATE	REV.	DESCRIPTION	DATE	SIZE	REV.	FILE NAME
1						A4	1.0	121B-150A10_B_1

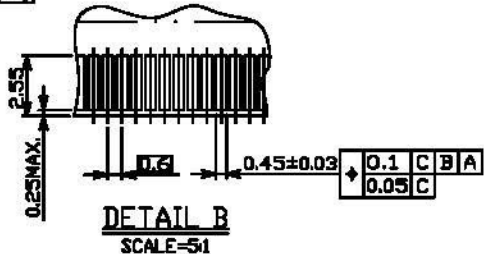
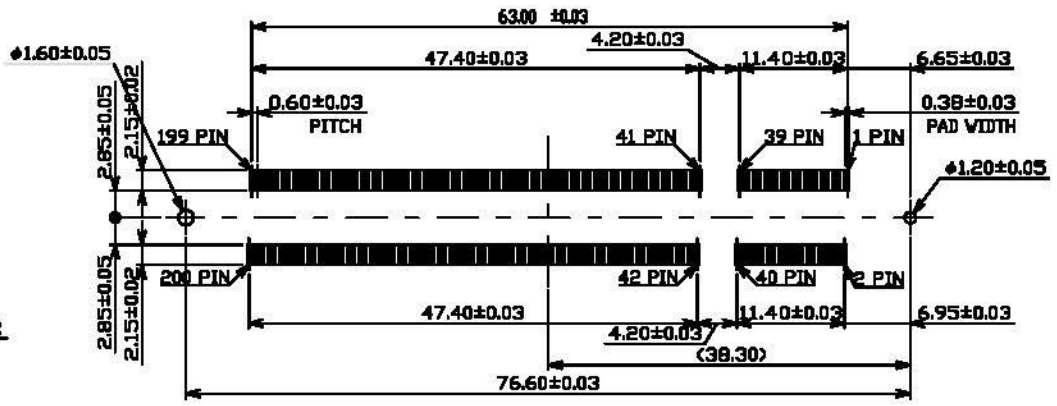
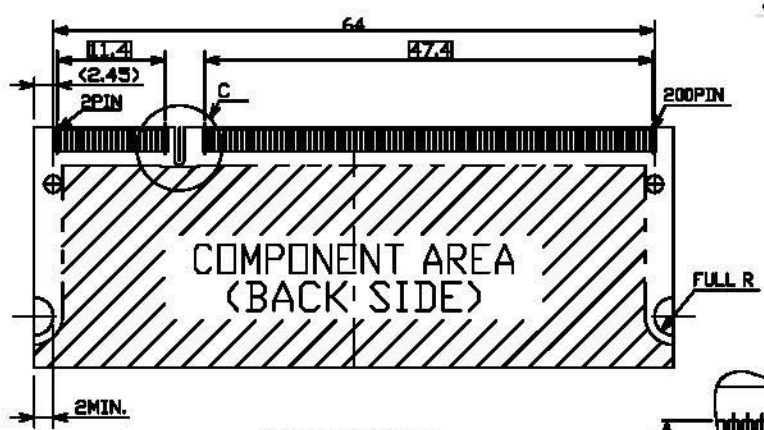
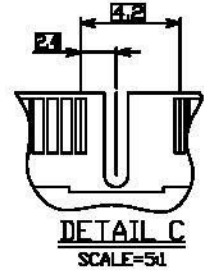
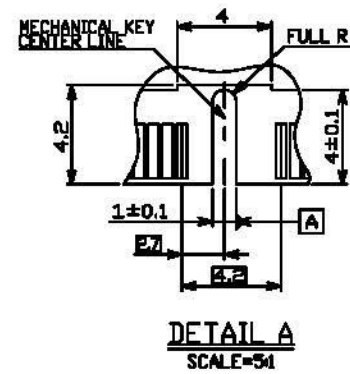
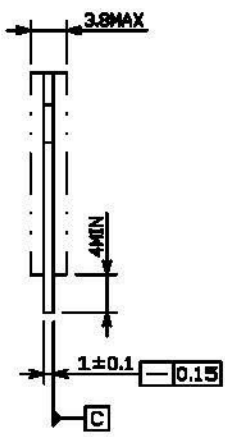
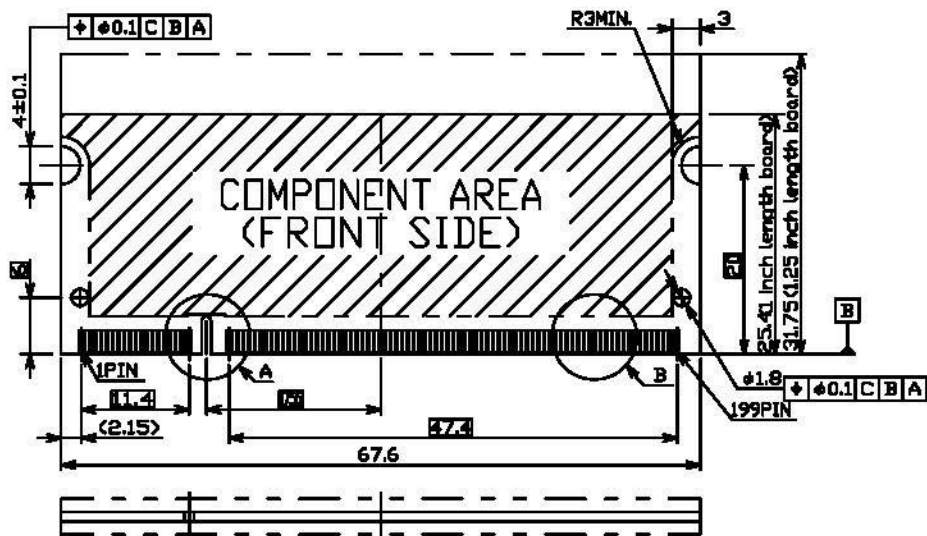

RECOMMENDED MOUNTING
P.C. BOARD DIM.

RECOMMENDED MOUNTING
P.C. BOARD PATTERN LAYOUT DIM.

						UNLESS OTHERWISE SPECIFIED TOLERANCE					
						ANGLES	ANG.	±5°			
						LINEAR	0.	±0.3	info@allconnectors.de		
							0.0	±0.25	Tel: 0049 741 7009303		
							0.00	±0.20	Fax: 0049 741 7009504		
						SCALE	AS SHOWN	UNIT: mm	/U/91 Hilderstadt - Germany		
						DRAWN	Willis	2012/12/05	DRAWN NAME:		
						CHECKED	Angel	2012/12/05	SO DIMM DDR2 Socket		
						APPROVED	Ken	2012/12/05	1.8V 200Pin 15.0H Vertical Reverse Type		
						REV. 1.0	FILE NAME	121B-150A10_B_1			
REV.	DESCRIPTION	DATE	REV.	DESCRIPTION	DATE	SIZE	M	REV.			
1											
2											
3											
4											
5											
6											
7											
8											
9											
10											

Revise:
Revise:
Revise:

All Connectors

www.allconnectors.de
Tel: 0049 741 7009303
/U/91 Hilderstadt - Germany

info@allconnectors.de
Fax: 0049 741 7009504
kettner@allconnectors.de

DRAWN NAME:
SO DIMM DDR2 Socket
1.8V 200Pin 15.0H Vertical Reverse Type

PRODUCT NO. 121B-150A10
FILE NAME 121B-150A10_B_1

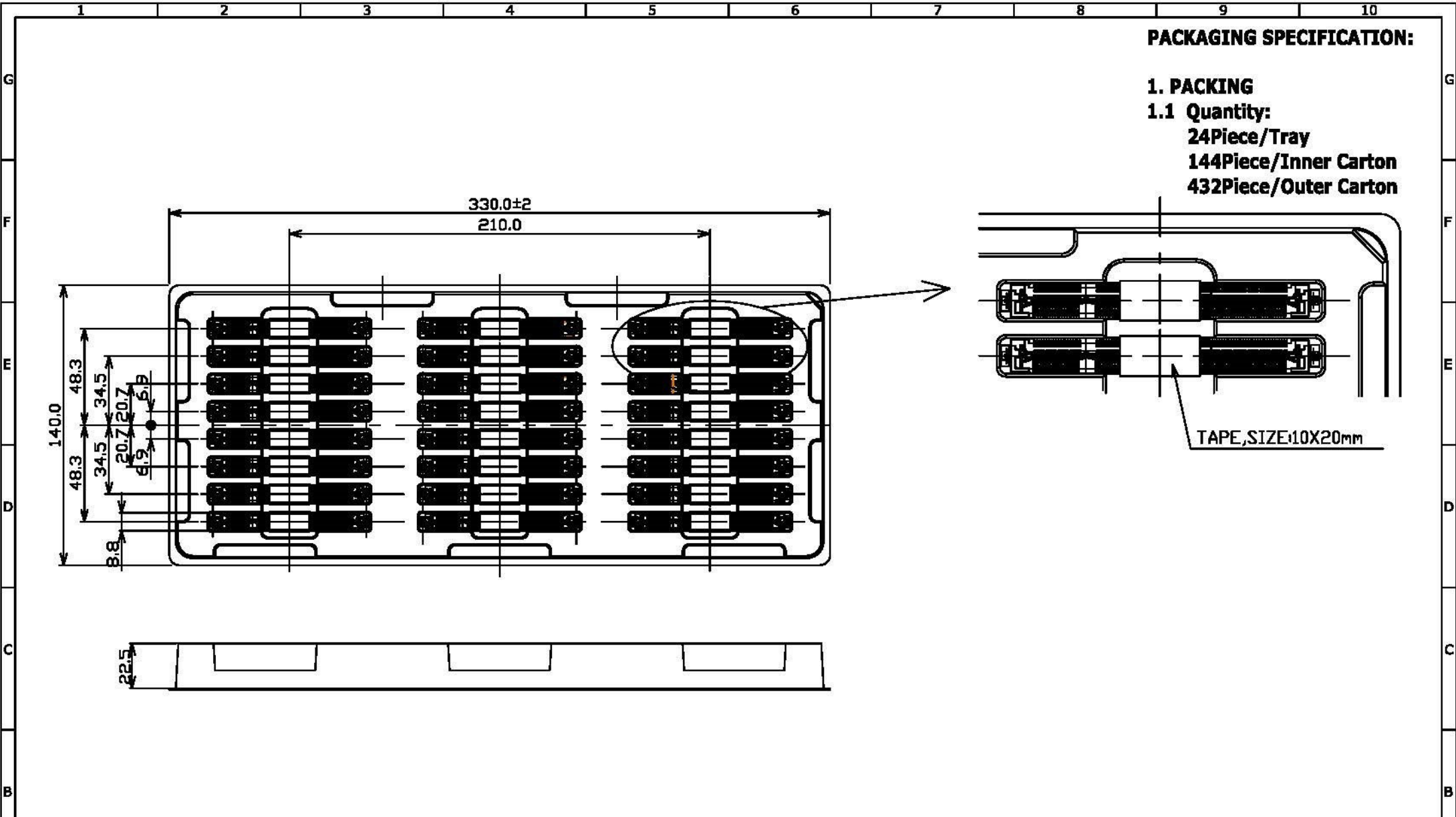

PACKAGING SPECIFICATION:

- 1. PACKING**
- 1.1 Quantity:**

 - 24 Piece/Tray**
 - 144 Piece/Inner Carton**
 - 432 Piece/Outer Carton**

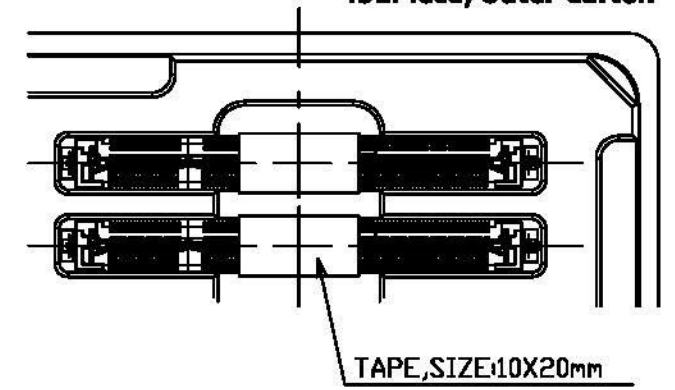

							UNLESS OTHERWISE SPECIFIED TOLERANCE				
							ANGLES	ANG.	+5°		
							LINEAR	0.	±0.3		
								0.00	±0.25		
							SCALE	AS SHOWN	UNIT: mm	www.allconnectors.de info@allconnectors.de Tel.: 0049 711 7005503 Fax: 0049 711 7005504 10/54 Hildenstadt - Germany Kothmannstr. 25	
							DRAWN	Willis	2012/12/05		
							CHECKED	Angel	2012/12/05		
							APPROVED	Ken	2012/12/05		
							DRAWN NAME: SO DIMM DDR2 Socket 1.8V 200Pin 15.0H Vertical Reverse Type			PRODUCT NO. 121B-150A10 FILE NAME 121B-150A10_D_1	
							SIZE A4 REV. 1.0				
REV.	DESCRIPTION	DATE	REV.	DESCRIPTION	DATE						
1			2								
3			4								
5			6								
7			8								
9			10								

△ Revise:

△ Revise:

△ Revise:

△

△

△