

SWITCH CIRCUIT

MATERIAL AND FINISH AS BELOW

WHEN CARD IS EJECTED

WHEN CARD IS INSERTED

A	Housing	LCP UL94V-0 Beige	E	
B	Contact	Phosphor Bronze C5210, Contact Area: Gold Flash	F	
C	Latch	Stainless Steel SUS301	G	
D			H	

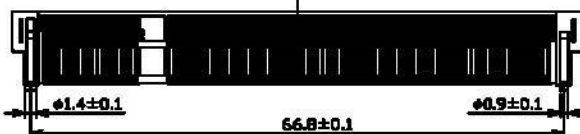
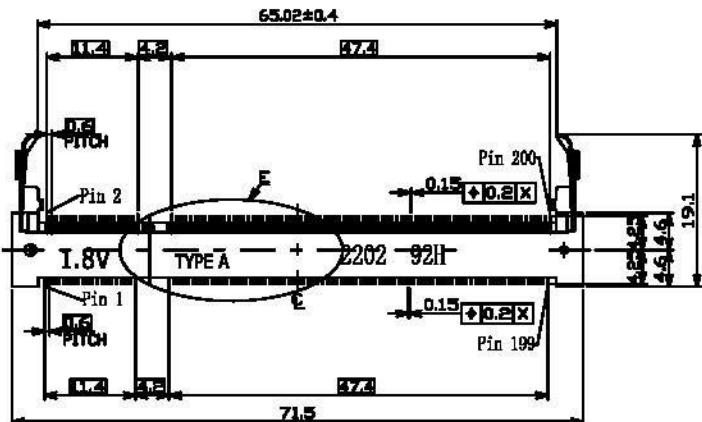

NOTES:  
 DATE CODE 2202 (YWWD)  
 Y: 2 YEAR (2012)  
 WW: 20 WEEK (01~52)  
 D: 2 DAY (01~07)

**SPECIFICATION:**

- ELECTRICAL**
  - 1.1 Current Rating: 0.5A per pin
  - 1.2 Voltage Rating: 25V AC/DC
  - 1.3 Contact Resistance: 60mΩ
  - 1.4 Insulation Resistance: 500MΩ
  - 1.5 Dielectric Withstanding Voltage: 125VAC

- MECHANICAL**
  - 2.1 Durability: 25 Cycle
  - 2.2 Latch Retention Force: 8 N/Pos. Min

- ENVIRONMENTAL**
  - 3.1 Operating temperature range: -40°C~+85°C
  - 3.2 Storage temperature range: -40°C~+85°C

- SOLDER ABILITY**
  - 4.1 Recommended IR Reflow Temperature: 255°C 10Sec

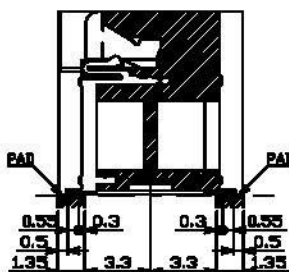
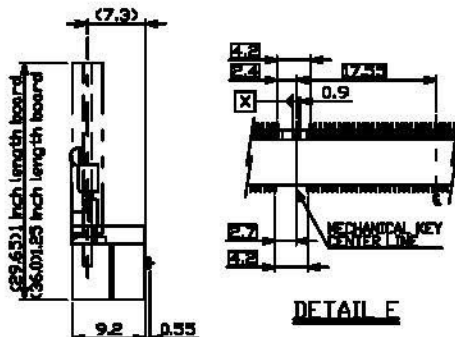

P1	P2	P3	P4	P5	P6	P7	P8	P9	P10	P11	P12
----	----	----	----	----	----	----	----	----	-----	-----	-----

PIN ASSIGNMENT

121A-92A00 SO DIMM DDR2 Socket 1.8V 200Pin Type H:9.2, Contact Area: Gold Flash

PRODUCT NO. DESCRIPTION

UNLESS OTHERWISE SPECIFIED TOLERANCE

ANGLES	ANG.	±5°
LINEAR	0.	±0.3
	0.0	±0.25
	0.00	±0.20

SCALE AS SHOWN UNIT: mm

DRAWN Willis 2012/12/05

CHECKED Angel 2012/12/05

APPROVED Ken 2012/12/05



www.allconnectors.de info@allconnectors.de  
 Tel: +49 89 711 700593 Fax: +49 89 711 700521  
 20754 Fichtenschlag, Germany info@msb.25

DRAWN NAME: SO DIMM DDR2 Socket 1.8V 200Pin 9.2H Type

PRODUCT NO. 121A-92A00

FILE NAME 121A-92A00\_B\_1

- △ Revise:
- △ Revise:
- △ Revise:

REV.	DESCRIPTION	DATE	REV.	DESCRIPTION	DATE	SIZE	REV.	FILE NAME
1						A4	1.0	121A-92A00_B_1

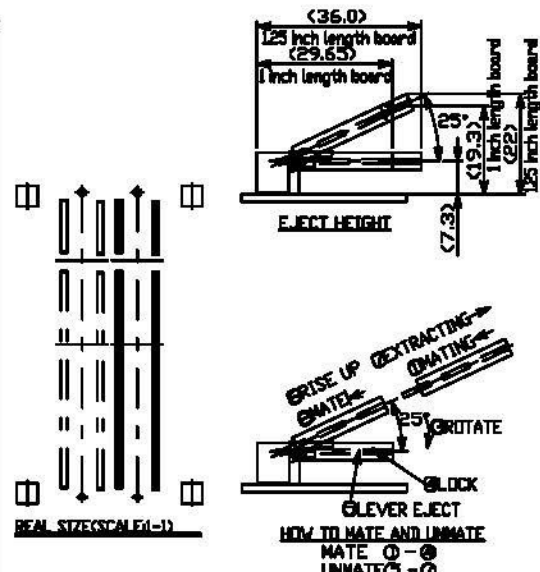
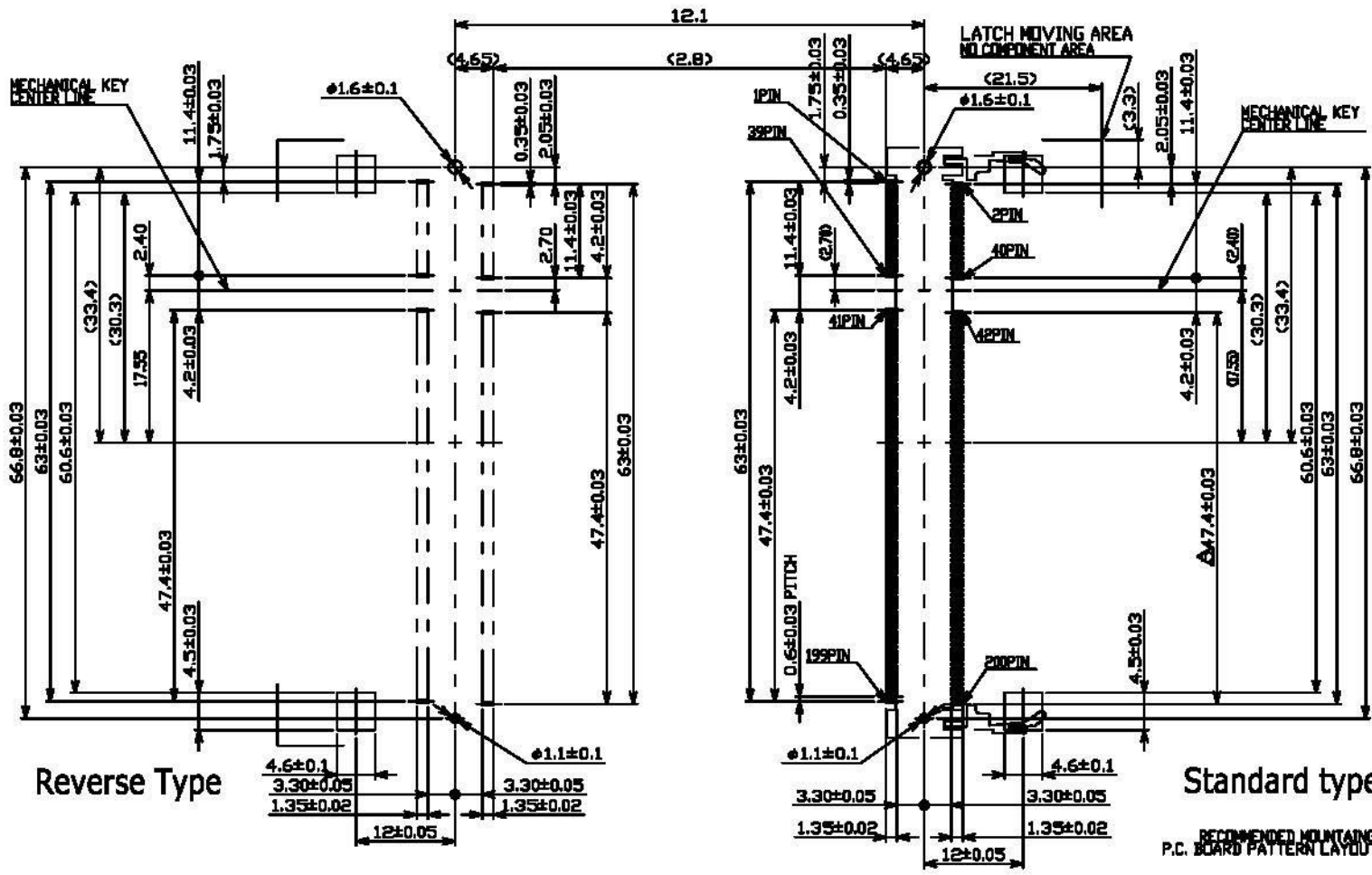

REAL SIZE (SCALE=1)

REV.	DESCRIPTION	DATE	REV.	DESCRIPTION	DATE	UNLESS OTHERWISE SPECIFIED TOLERANCE			 www.allconnectors.de info@allconnectors.de Tel.: 0049 711 7002501 Fax: 0049 711 7002504 · 70724 Pilderstet - Germany tetemestr. 25	
						ANGLES	ANG.	±SP		
						LINEAR	0.0	±0.25		
						SCALE	AS SHOWN	UNIT: mm		
						DRAWN	Willis	2012/12/05	DRAWN NAME: SO DIMM DDR2 Socket 1.8V 200Pin 9.2H Type	
						CHECKED	Angel	2012/12/05	PRODUCT NO. 121A-92A00	
						APPROVED	Ken	2012/12/05	FILE NAME 121A-92A00_B_1	
						SIZE	M	REV. 1.0		

△ Revise:  
△ Revise:  
△ Revise:

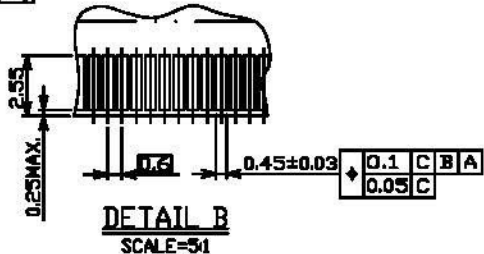
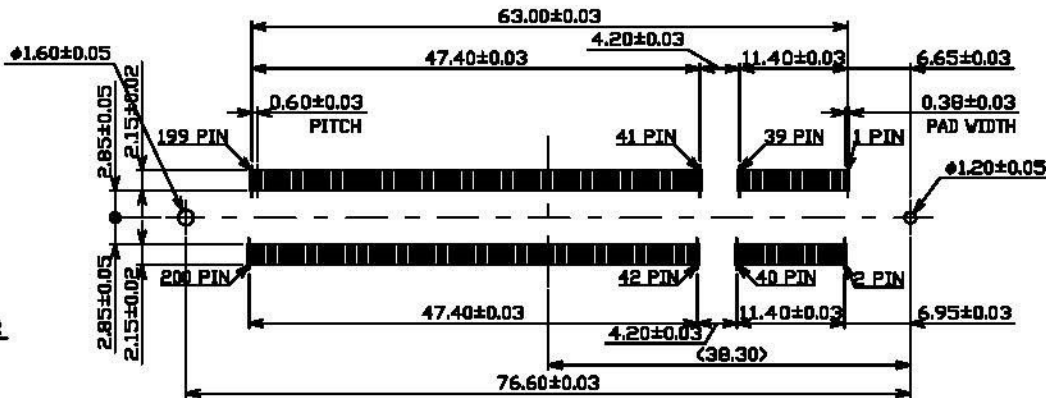
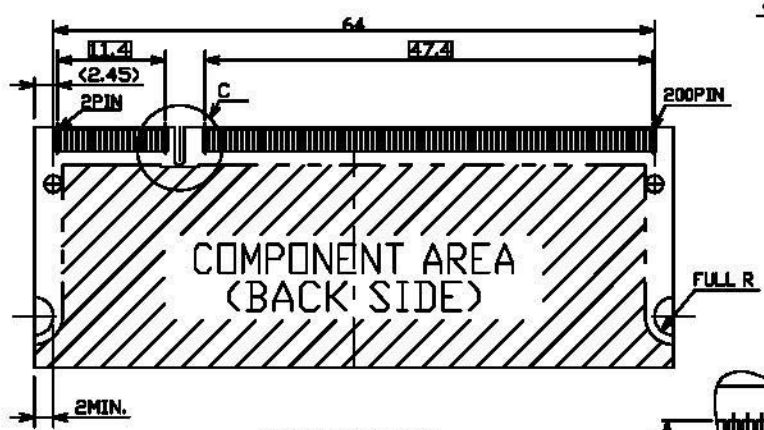
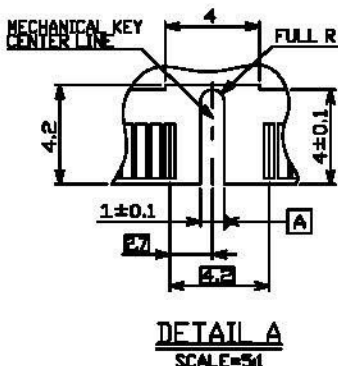
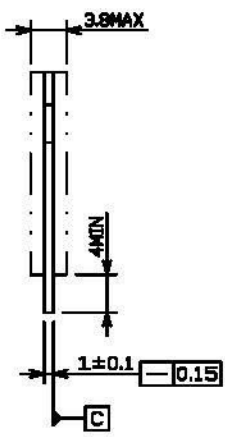
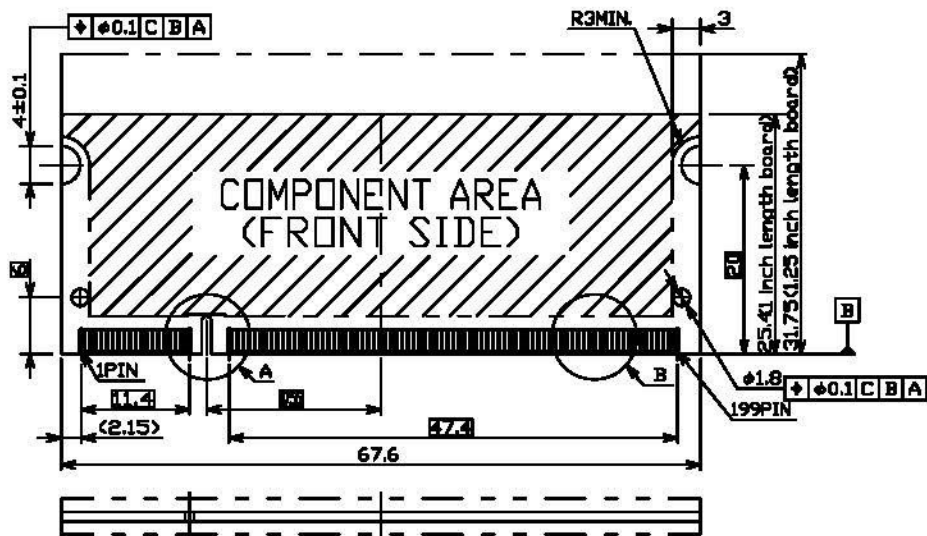

RECOMMENDED MOUNTING P.C. BOARD DIM.

RECOMMENDED MOUNTING P.C. BOARD PATTERN LAYOUT DIM.

REV.	DESCRIPTION	DATE	REV.	DESCRIPTION	DATE	SIZE	REV.	FILE NAME
1			2			M	1.0	121A-92A00_B_1

UNLESS OTHERWISE SPECIFIED TOLERANCE		
ANGLES	ANG.	±5°
LINEAR	0.	±0.25
	0.00	±0.20
SCALE	AS SHOWN	UNIT: mm
DRAWN	Willis	2012/12/05
CHECKED	Angel	2012/12/05
APPROVED	Ken	2012/12/05

  

<b>All connectors</b>	
www.allconnectors.de	info@allconnectors.de
Tel: +0049 7141 7005500	Fax: +0049 7141 7005504
70814 Filderstadt - Germany	Kellernstraße 23

DRAWN NAME:	SO DIMM DDR2 Socket 1.8V 200Pin 9.2H Type
PRODUCT NO.	121A-92A00



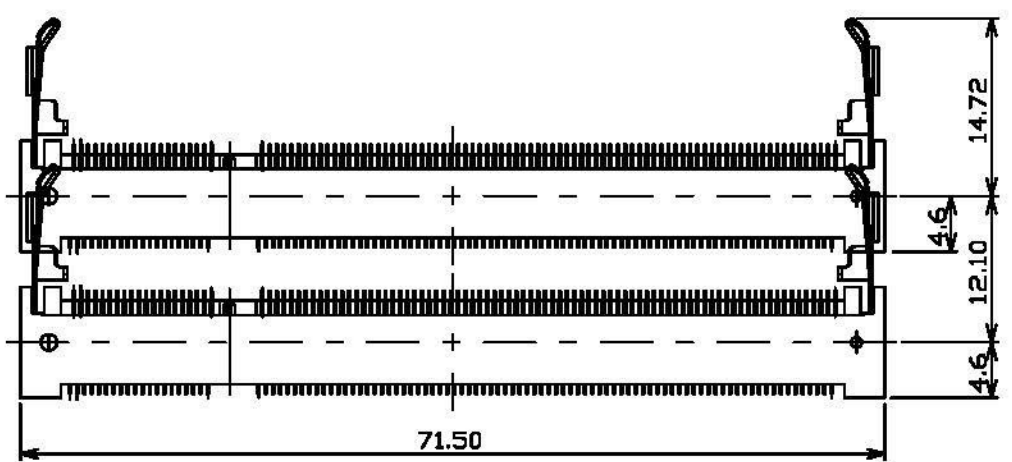
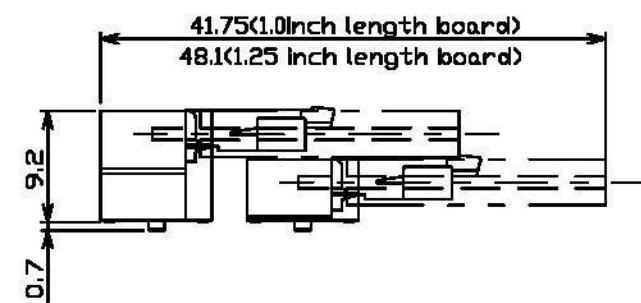
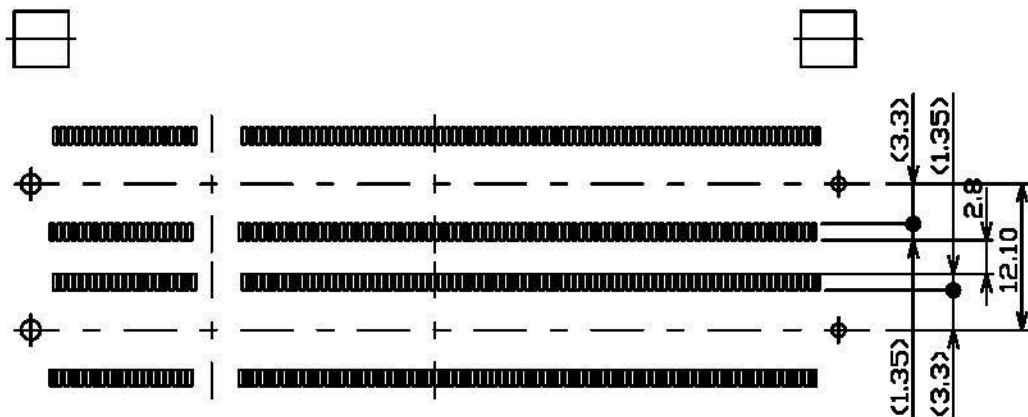

Combination Dimension for H=5.2(Standard) connector  
 121A-52A00 H=5.2 and 121A-92A00 H=9.2

REV.	DESCRIPTION	DATE	REV.	DESCRIPTION	DATE	UNLESS OTHERWISE SPECIFIED TOLERANCE			All connectors	
						ANGLES	ANG.	±5.3	www.allconnectors.de Tel.: 0049 711 700503 70754 Filderstadt - Germany	info@allconnectors.de Fax: 0049 711 700504 Kartenstr. 33
					LINEAR	0.0	±0.25			
						0.00	±0.20			
						SCALE	AS SHOWN	UNIT: mm	DRAWN NAME:	
						DRAWN	Willis	2012/12/05	SO DIMM DDR2 Socket 1.8V 200Pin 9.2H Type	
						CHECKED	Angel	2012/12/05	PRODUCT NO.	121A-92A00
						APPROVED	Ken	2012/12/05	FILE NAME	121A-92A00_B_1
						SIZE	A4	REV.	1.0	

- △ Revise:
- △ Revise:
- △ Revise:

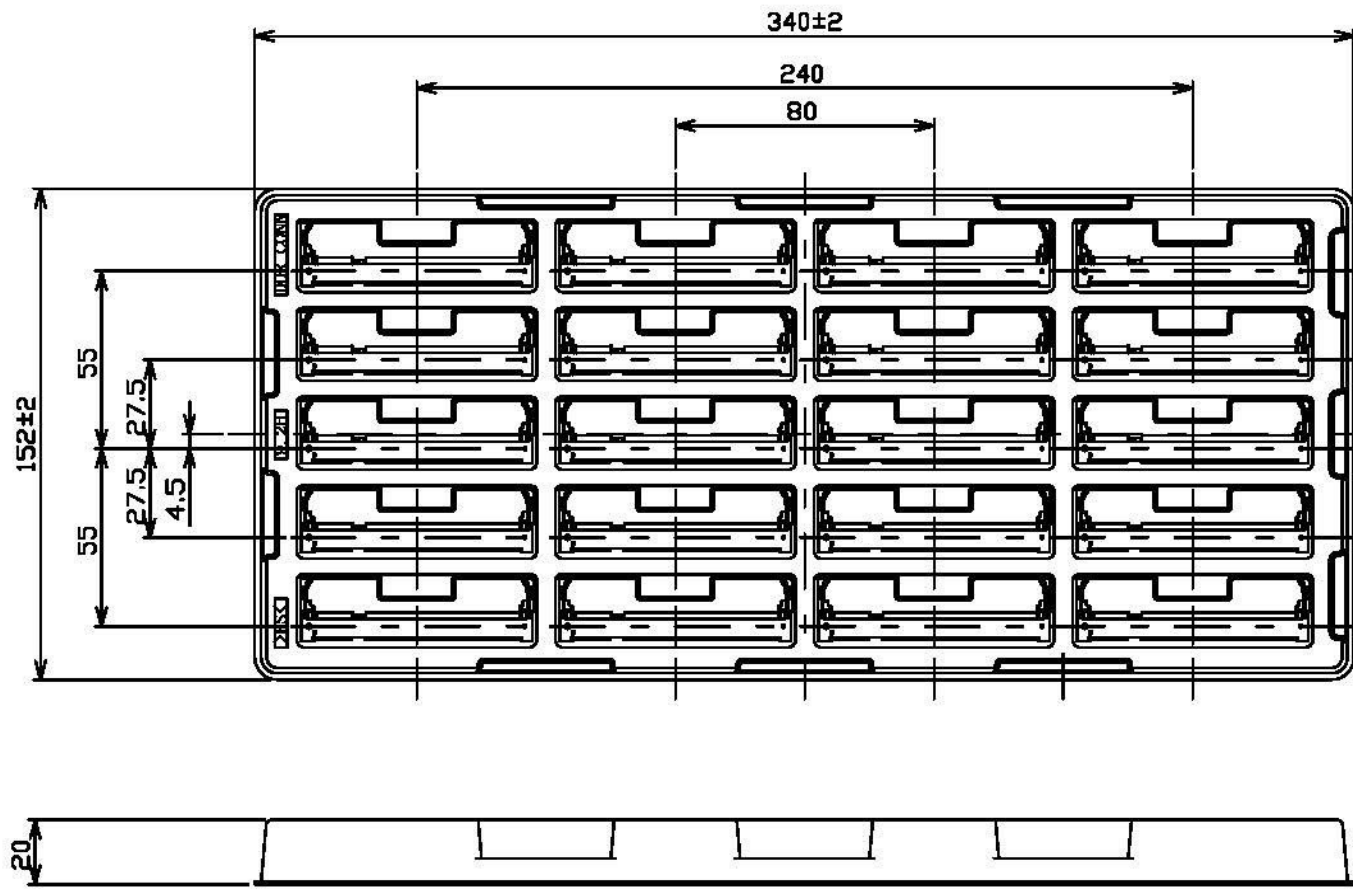

**PACKAGING SPECIFICATION:**

- 1. PACKING**
- 1.1 Quantity:**

  - 20 Piece/Tray**
  - 160 Piece/Inner Carton**
  - 480 Piece/Outer Carton**

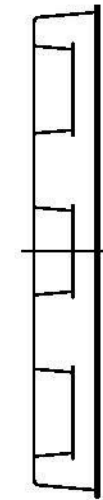

SOFT TRAY PACKAGING

						UNLESS OTHERWISE SPECIFIED TOLERANCE				
						ANGLES	ANG.	±5P		
						LINEAR	0.	±0.3	www.allconnectors.de      info@allconnectors.de Tel: 0049 7211 7005603      Fax: 0049 7211 7005604 70734 Filderstadt - Germany      Technastr. 25	
							0.00	±0.20		
						SCALE	AS SHOWN	UNIT: mm	DRAWN NAME: <b>SO DIMM DDR2 Socket 1.8V 200Pin 9.2H Type</b> PRODUCT NO.    121A-92A00 FILE NAME        121A-92A00_D_1	
						DRAWN	Willis	2012/12/05		
						CHECKED	Angel	2012/12/05		
						APPROVED	Ken	2012/12/05		
REV.	DESCRIPTION	DATE	REV.	DESCRIPTION	DATE	SIZE    M4    REV.    1.0				
1			4		7					

- △ Revise:
- △ Revise:
- △ Revise: