

REV	DESCRIPTION	APPROVAL	DATE
A	新制定		06.06.14

Material:
 Insulator: ABS UL94-HB
 Color:
 X= G: Gray
 X= K: Black
 X= C: Nickel Plated
 Metal Parts : Steel/Nickel plated

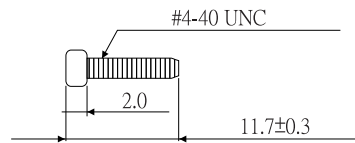
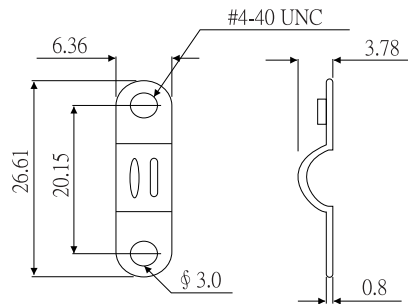
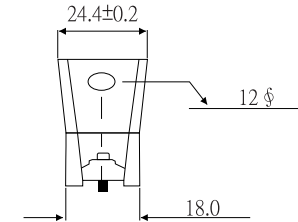
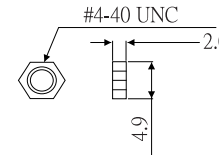
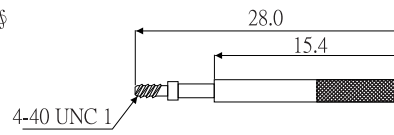
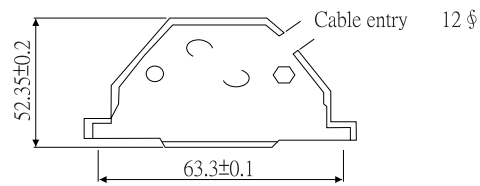
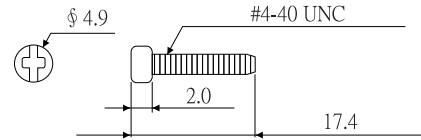
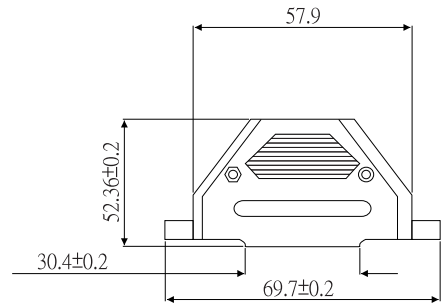

PART NO:
 HS3701x02R1: PLASTIC
 HS3703C02R1: PLASTIC CHROMATED
 (METALLIC)

 www.allconnectors.eu info@allconnectors.eu Tel. +49 (0)711 / 358 110 20 Fax +49 (0)711 / 358 110 25		DRAWN BY	TOMMY
		CHECKED	
TITLE:	D-Sub Metalloid Hood		APPROVED
PART NO:	H3703C01-R1		DRAW NO
DRAW. BOX NO:			
SCALE	REV	A	UNIT mm

