

1 2 3 4 5 6 7 8 9 0

J

I

H

G

F

E

D

C

B

A

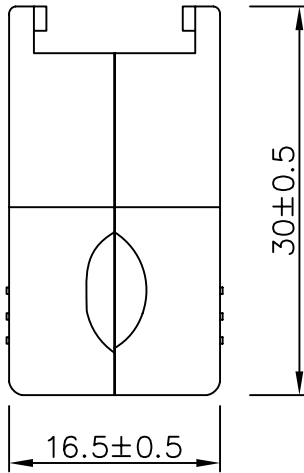
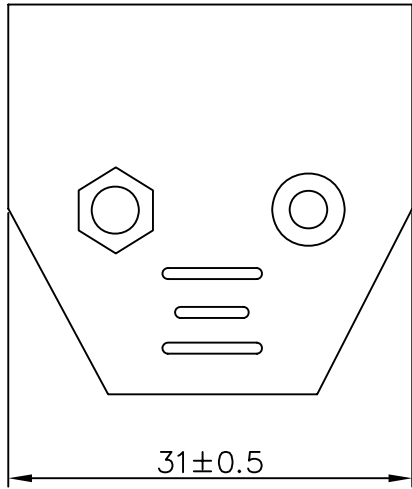

MATERIALS:

HOOD: ABS UL 94HB

COLOR BLACK OR METALIZED

SCREW: STEEL WITH NICKEL PLATED

CABIA CLIPPER: STEEL WITH NICKEL PLAED

DKH-K1-09-LF

LEADFREE

RoHS Compliant

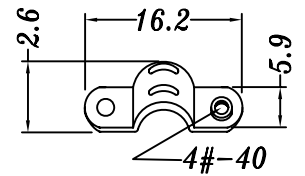
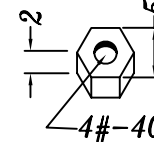
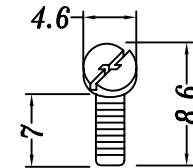
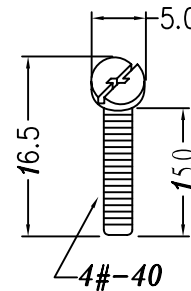
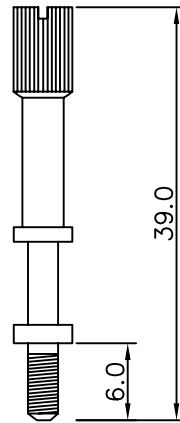
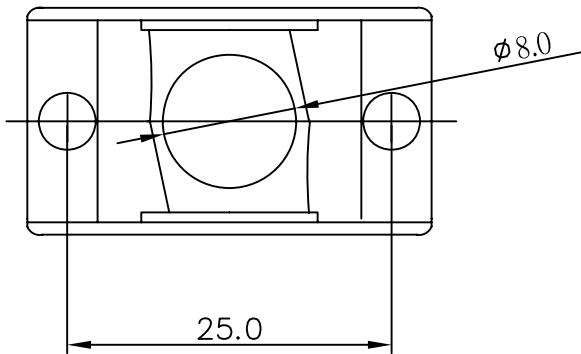

All Connectors

www.allconnectors.eu | info@allconnectors.eu
Tel. +49 (0)711 / 358 110 20 | Fax +49 (0)711 / 358 110 25

PART NO. DKH-K1-09

DWG NO. DKH-K1-09

FILE NO.

UNIT / mm

SCALE 1:1

CHECKED BY CY

DRAWING BY

PROJECTION



TOLERANCES ARE

.X ±
.XX ±
.XXX ±
AWG

DESCRIPTION:

AREA

REVISIONS

HK

DATE