

SERIES D-SUB MINIATURE ACCESSORIES
 09P, LONG SCREW
 HOOD MATERIAL: CRS/POLYESTER
 FINISH: A> HOOD - CHROME PLATED
 B> SCREW NUT & CLIP AND OTHER, NICKEL PLATED

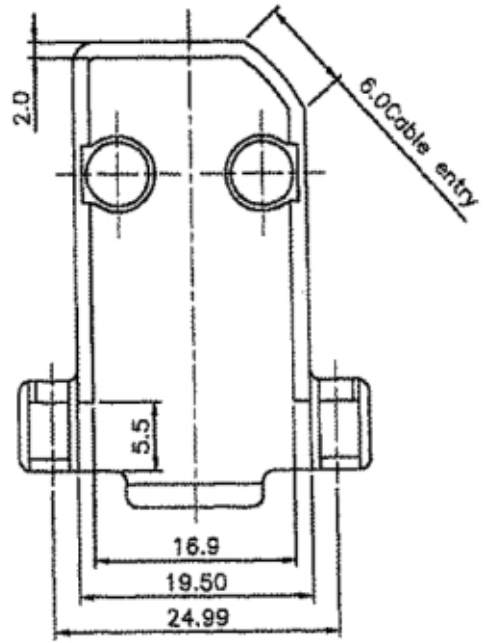
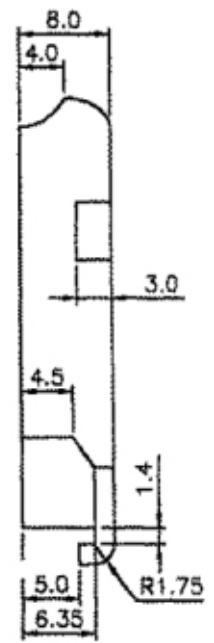
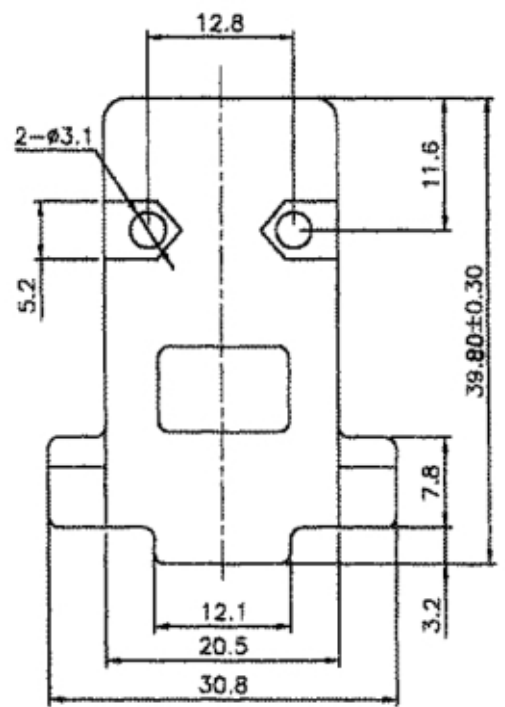

G: Gray
 B: Black
 C: Chromate Clotr
 No. Of Postions

DHR-x1T-09-LF
 LEADFREE

G:GRAY
 K:BLACK
 C:CHROMATE

RoHS Compliant

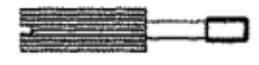

2PCS

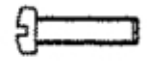

2PCS

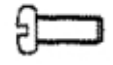

2PCS



2PCS

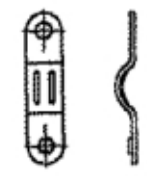

2PCS

PART NO. DHR-x1T-09		CHECKED BY CY		TOLERANCES ARE .X ± 0.2 .XX ± 0.1 .XXX ± AWG	DESCRIP TION:			
DWG NO. DHR-x1T-09		DRAWING BY						
UNIT / mm		SCALE 1:1	PROJECTION	AREA	REVISIONS	HK	DATE	