

1 2 3 4 5 6 7 8 9 0

J
I
H
G
F
E
D
C
B
A

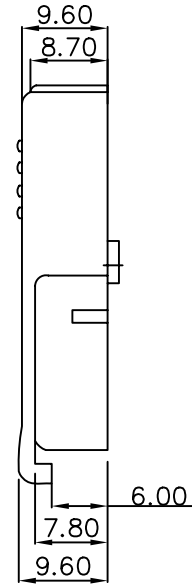
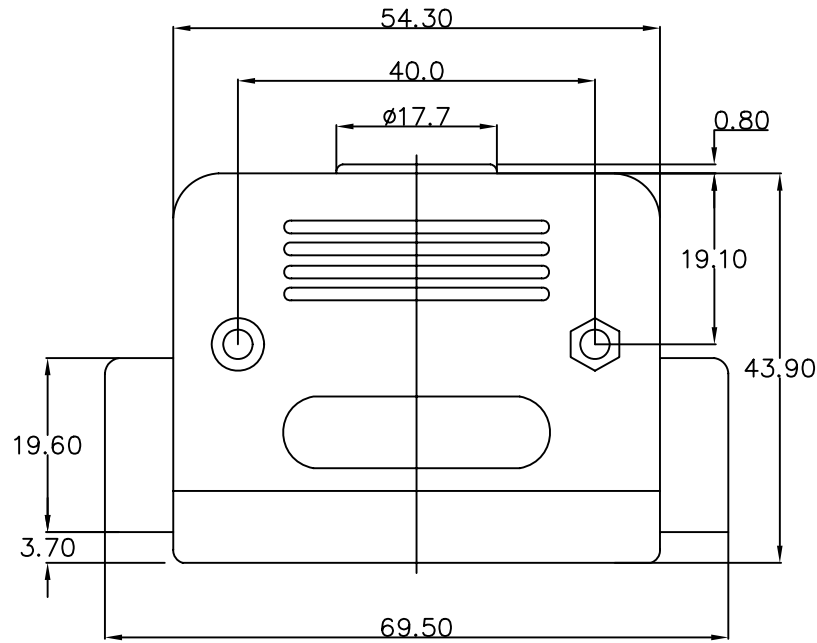

Material:
*Insulator: ABS

DHL-G1-50
T
G: GREY
K: BLACK
B: BEIGE
C: CHROMATE

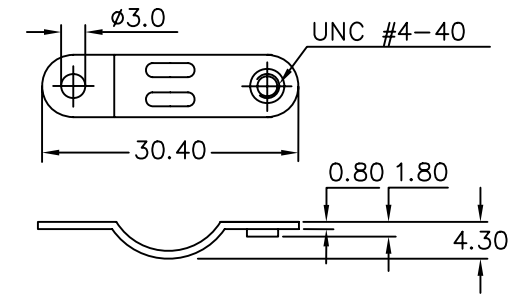
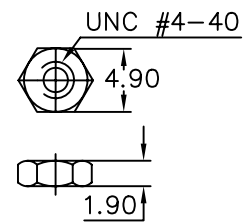
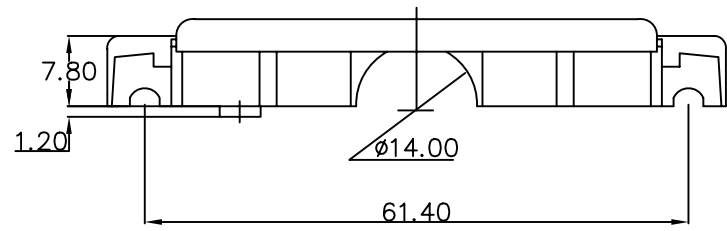
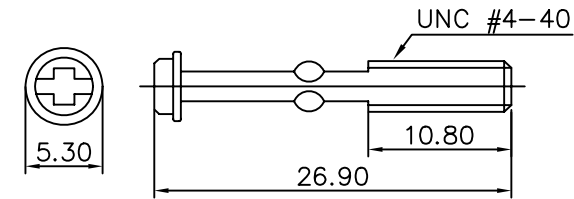
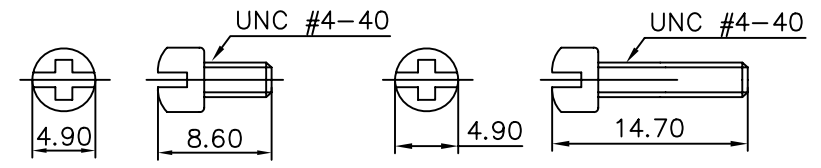

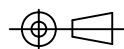
PART NO. DHL-G1-50		CHECKED BY CY		TOLERANCES ARE		DESCRIP TION:	
DWG NO. DHL-G1-50		DRAWING BY		.X ± 0.2		AREA	
FILE NO.		PROJECTION 		.XX ±		REVISIONS	
UNIT / mm	SCALE 1:1			.XXX ±		HK	
				AWG		DATE	