

J

I

H

G

F

E

D

C

B

A

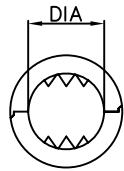

DIA: 6.0,7.0,8.0,9.0mm

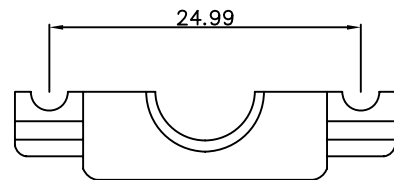
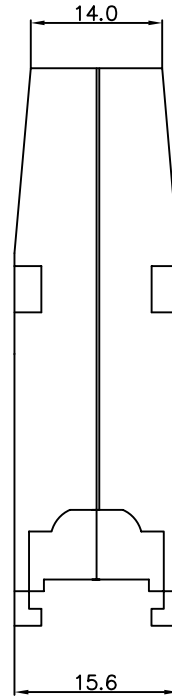
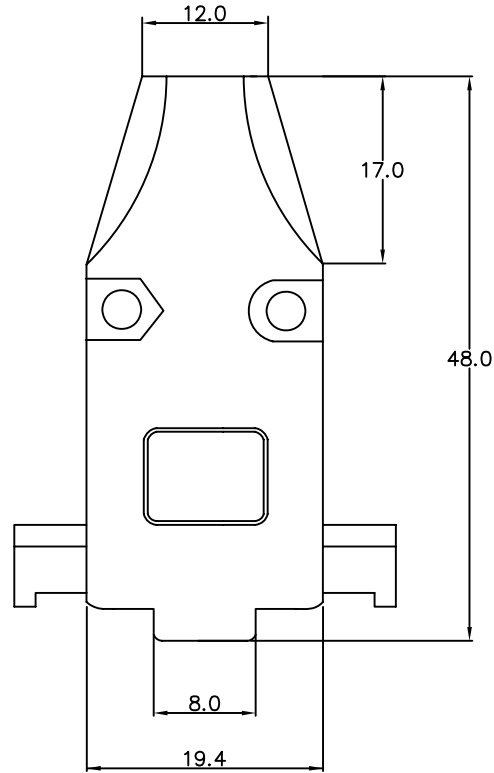

MATERIAL:

HOUSING: ZINC ALLOY DIE CAST, NICKEL PLATED

ACCESSORIES: STEEL/NICKEL PLATED

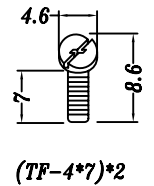
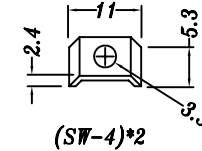
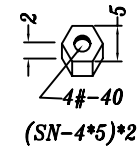
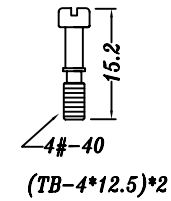
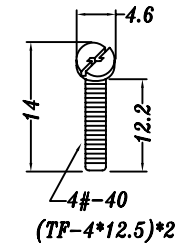

All Connectors

www.allconnectors.eu | info@allconnectors.eu
Tel. +49 (0)711 / 358 110 20 | Fax +49 (0)711 / 358 110 25

PART NO. DHA-N1Dxx-09

DWG NO. DHA-N1Dxx-09

FILE NO.

UNIT / mm

SCALE 1:1

CHECKED BY CY

DRAWING BY

PROJECTION

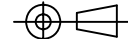

TOLERANCES ARE

.X ± 0.2
.XX ±
.XXX ±
AWG

DESCRIPTION:

AREA

REVISIONS

HK

DATE