

1 2 3 4 5 6 7 8 9 0

J
I
H
G
F
E
D
C
B
A

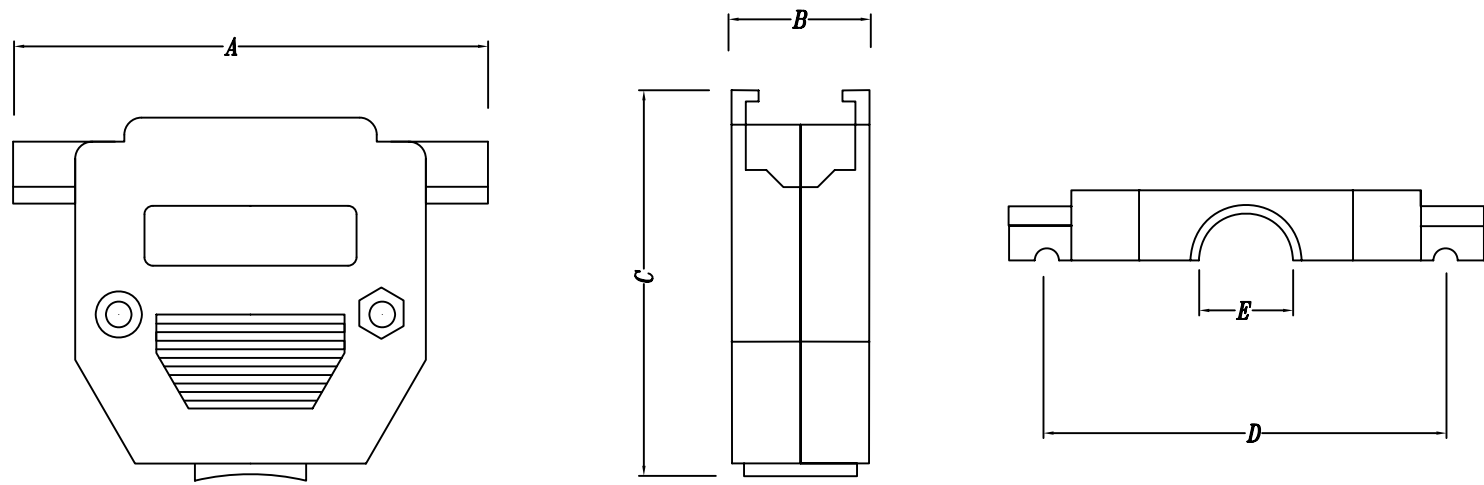

MATERIAL
INSULATOR:ABS 94-HB

DH-G1-09

COLOR	POSITION
G:GREY	09:09 AWY
B:BEIGE	15:15 AWY
K:BLACK	25:25 AWY
C:CHROMATE	37:37 AWY

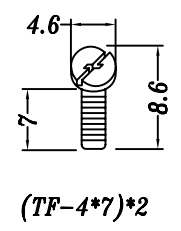
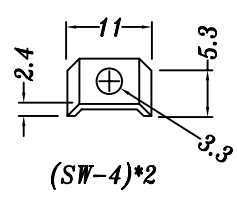
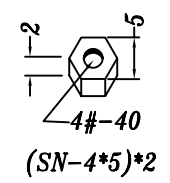
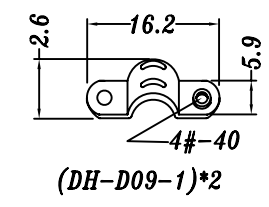
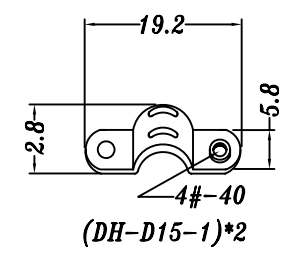
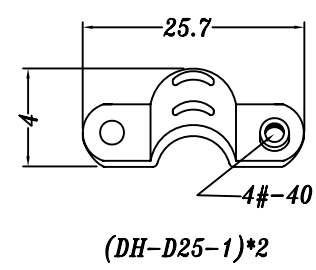
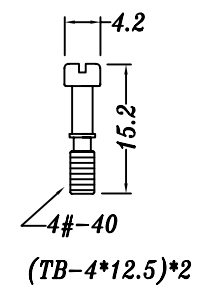
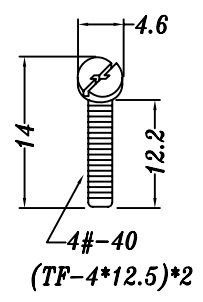

	37P	25P	23P	15P	09P
A	69.5	55	50.2	40	30.5
B	20	16	16.2	16.2	16
C	53	44.5	41.7	37.4	41
D	63	47	44	33.5	25
E	14	10.5	10.1	10	7

Allconnectors

www.allconnectors.eu | info@allconnectors.eu
Tel. +49 (0)711 / 358 110 20 | Fax +49 (0)711 / 358 110 25

PART NO. DH-x1-xx

DWG NO. DH-x1-xx

FILE NO.

UNIT / mm

APPROVED BY CY

DRAWING BY

PROJECTION

SCALE 1:1

TOLERANCES ARE

.X
.XX
.XXX
AWG



DESCRIPTION:

AREA	REVISIONS	HK	DATE