

Pin Type	Interface Dim L	Pin Type
Defect	3.5 mm	25,26
General	4.25 mm	All Other Pins
Power	5.0 mm	1,13,38,50

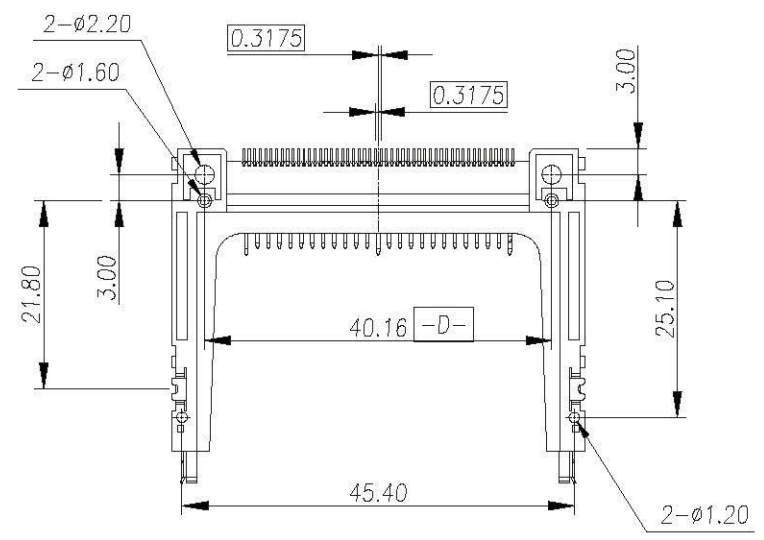

Ordering Information:

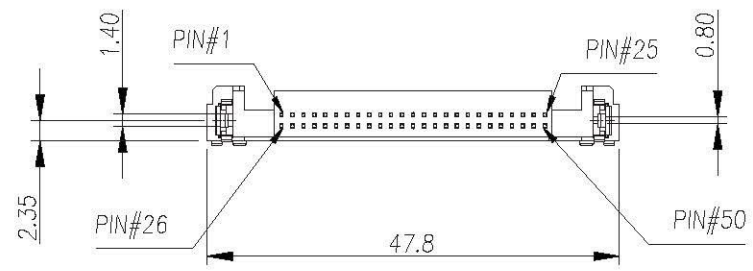

RoHS Compliant

All Connectors

www.allconnectors.de info@allconnectors.de
 Tel.: 0049 711 7009503 Fax: 0049 711 7009504
 70794 Filberstadt, Germany Kettnerstr. 25

DRAWING BY CY
 CHECKED BY GENIUS
 UNIT / mm SCALE 1 : 1
 DATE
 SIZE A4 PPROJECTION

TOLERANCES ARE
 X ±
 .X ±
 .XX ±
 .XXX ±
 ANG ±

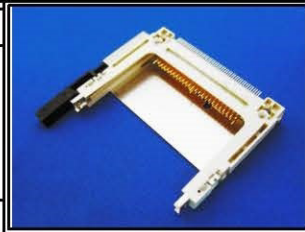

ORDER INFORMATION

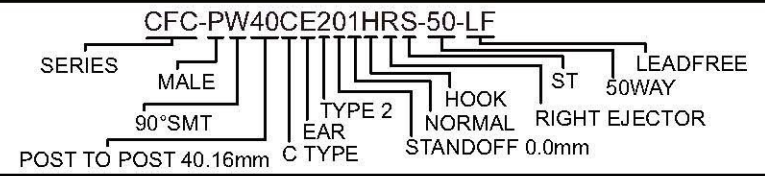

DESCRIPTION: CF TYPE2 ,50PIN SMT NORMAL TYPE

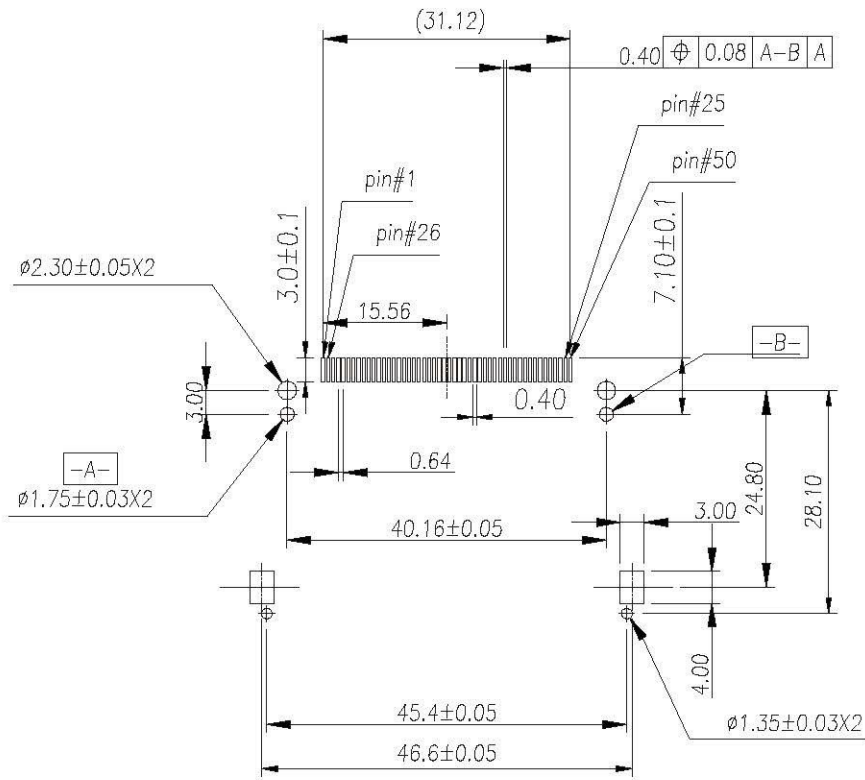

P.C.B Layout

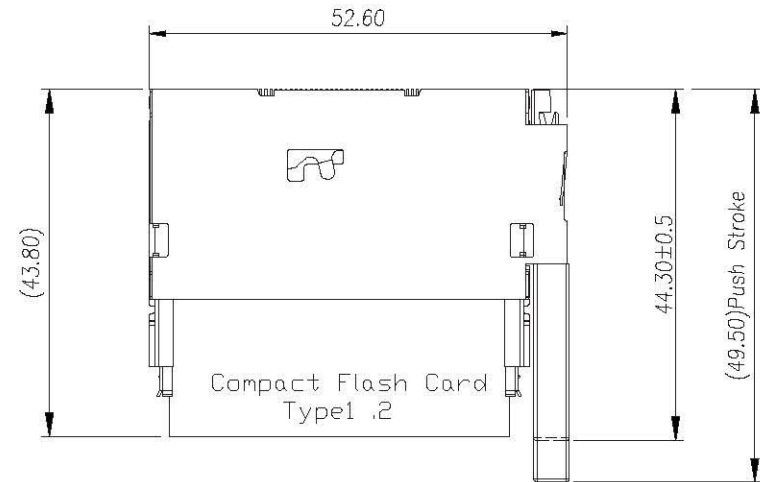

Header With Ejector

SPECIFICATIONS:

- HOUSING : High Temperature Plastic, UL 94V-0
- CONTACT : Copper Alloys
- VOLTAGE RATING : 100VAC
- CURRENT RATING : 0.5A
- CONTACT RESISTANCE:40 m Ohm max.
- INSULATION RESISTANCE:1000M Ohm min.
- DIELECTRIC STRENGTH : 500VAC/1min
- OPERATION TEMPERATURE : -40°C~85°C

RoHS Compliant

All Connectors

www.allconnectors.de info@allconnectors.de
 Tel.: 0019 711 7009508 Fax: 0019 711 7009504
 70794 Filderstadt - Germany Kettnerstr. 75

DRAWING BY CY	
CHECKED BY GENIUS	
UNIT / mm	SCALE 1 : 1
DATE	
SIZE A4	P PROJECTION

TOLERANCES ARE

- X ±
- .X ±
- .XX ±
- .XXX ±
- ANG ±

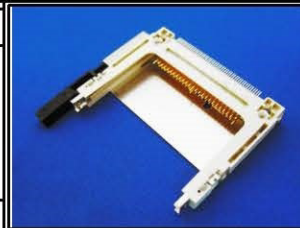

ORDER INFORMATION

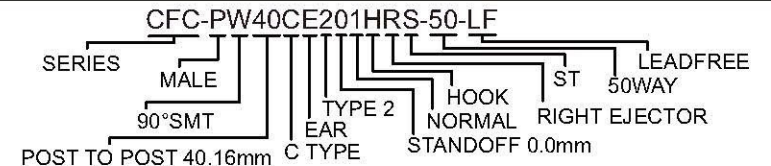

DESCRIPTION: CF TYPE2 ,50PIN SMT NORMAL TYPE